



**Tecnologia  
a portata di mano**

Technology in your hand  
Technologie à portée de main

**AUSTRALIAN s.r.l.**

10061 Cavour (TO) Italy - Via Nuova,19  
Tel. +39 0121.600 752 / +39 0121.600 820  
Fax +39 0121.609 427

**[www.australiantools.it](http://www.australiantools.it)**

email: [commerciale@australian-srl.com](mailto:commerciale@australian-srl.com)  
skype: australiansrl

4  
17  
24  
26  
30  
39  
51  
54  
60  
68  
78  
83  
88  
92  
98  
112  
120  
121  
123  
138

MARTELLERIA

MAZZE e  
PICCONI

SCALPELLI e  
LEVERINI

ARTICOLI PER  
PIETRA

SECCHI, CAZZUOLE,  
SPATOLE e VARIE

BADILI, PALE,  
RASCHIETTI  
e RASCHIAFANGO

ACCETTE, PICOZZINI,  
RONCOLE e MACETE

ASCE, MAZZESCURI  
e CUNEI

RASTRELLI,  
SARCHIATORI  
e AERATORI

SCOPE FOGLIE

RACCOLTA FRUTTA  
e TRATTAMENTO

NOVITÀ

FORCHE  
e VANGHE

ZAPPE, ZAPPINI,  
ATTREZZINI  
e FORBICI

MANICI FIBRA

MANICI MIX  
e LEGNO

ASTE  
TELESCOPICHE

ESPOSITORI

GUANTI

SOLLEVAMENTO  
e ANCORAGGIO



**MARTELLERIA**

**Pag. 4 / 19**



**MAZZE e PICCONI**

**Pag. 20 / 23**



**SCALPELLI e LEVERINI**

**Pag. 24 / 25**



**ARTICOLI PER PIETRA**

**Pag. 26**



**SECCHI, CAZZUOLE,  
SPATOLE e VARIE**

**Pag. 27 / 38**



**BADILI, PALE, RASCHIETTI  
e RASCHIAFANGO**

**Pag. 39 / 51**



**ACCETTE, PICOZZINI,  
RONCOLE e MACETE**

**Pag. 52 / 54**



**ASCE, MAZZESCURI  
e CUNEI**

**Pag. 55 / 59**



**RASTRELLI, SARCHIATORI  
e AERATORI**

**Pag. 61 / 68**



**SCOPE FOGLIE, OLIVE  
e NOCCIOLE**

**Pag. 69 / 77**



**RACCOLTA FRUTTA e TRATTAMENTO** / **Pag. 78 / 83**



**NOVITÀ** / **Pag. 84 / 89**



**FORCHE e VANGHE** / **Pag. 90 / 93**



**ZAPPE, ZAPPINI, ATTREZZINI e FORBICI** / **Pag. 94 / 100**



**MANICI FIBRA** / **Pag. 101 / 114**



**MANICI MIX e LEGNO** / **Pag. 115 / 122**



**ASTE TELESCOPICHE** / **Pag. 123**



**ESPOSITORI** / **Pag. 124 / 125**



**GUANTI** / **Pag. 126 / 139**



**SOLLEVAMENTO e ANCORAGGIO** / **Pag. 140 / 144**

MARTELLERIA	4
MAZZE e PICCONI	17
SCALPELLI e LEVERINI	24
ARTICOLI PER PIETRA	26
SECCHI, CAZZUOLE, SPATOLE e VARIE	30
BADILI, PALE, RASCHIETTI e RASCHIAFANGO	39
ACCETTE, PICOZZINI, RONCOLE e MACETE	51
ASCE, MAZZESCURI e CUNEI	54
RASTRELLI, SARCHIATORI e AERATORI	60
SCOPE FOGLIE	68
RACCOLTA FRUTTA e TRATTAMENTO	78
NOVITÀ	83
FORCHE e VANGHE	88
ZAPPE, ZAPPINI, ATTREZZINI e FORBICI	92
MANICI FIBRA	98
MANICI MIX e LEGNO	112
ASTE TELESCOPICHE	120
ESPOSITORI	121
GUANTI	123
SOLLEVAMENTO e ANCORAGGIO	138

4 MARTELLERIA

20 MAZZE e PICCONI

24 SCALPELLI e LEVERINI

26 ARTICOLI PER PIETRA

27 SECCHI, CAZZUOLE, SPATOLE e VARIE

39 BADILI, PALE, RASCHIETTI e RASCHIAFANGO

52 ACCETTE, PICOZZINI, RONCOLE e MACETE

55 ASCE, MAZZESCURI e CUNEI

61 RASTRELLI, SARCHIATORI e AERATORI

69 SCOPE FOGLIE

78 RACCOLTA FRUTTA e TRATTAMENTO

84 NOVITÀ

90 FORCHE e VANGHE

94 ZAPPE, ZAPPINI, ATTREZZINI e FORBICI

101 MANICI FIBRA

115 MANICI MIX e LEGNO

123 ASTE TELESCOPICHE

124 ESPOSITORI

126 GUANTI

140 SOLLEVAMENTO e ANCORAGGIO



**Mazzetta antivibrazione antisfilamento con manico anima in fibra di vetro (impugnatura in gomma)**

Anti-vibration anti-unthreading club hammer with glass fibre core handle (rubber haft)  
Massette antivibration angles abattus avec manche trimatière

COD. ART.	Gr.	L mm	BOX	COD. EAN - 13
MM 800G AV	800	275	6	80 3264633 714 3
MM 1000G AV	1000	275	6	80 3264633 715 0
MM 1250G AV	1250	275	6	80 3264633 716 7
MM 1500G AV	1500	275	6	80 3264633 717 4
MM 2000G AV	2000	275	6	80 3264633 718 1

Mercato / Markets / Marchés



**Mazzetta antisfilamento con manico anima in fibra di vetro (impugnatura in gomma)**

Anti-unthreading club hammer with glass fibre core handle (rubber haft)  
Massette antieffilement angles abattus avec manche trimatière

COD. ART.	Gr.	L mm	BOX	COD. EAN - 13
MM 800 G	800	260	6	80 3264633 081 6
MM 1000 G	1000	260	6	80 3264633 082 3
MM 1250 G	1250	260	6	80 3264633 199 8
MM 1500 G	1500	260	6	80 3264633 084 7
MM 2000 G	2000	260	6	80 3264633 331 2

Mercato / Markets / Marchés

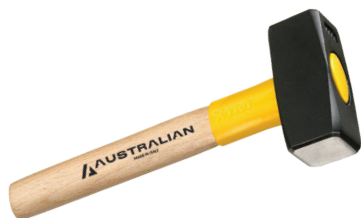

**Mazzetta antisfilamento con manico in legno Mix**

Anti-unthreading club hammer with wooden handle Mix  
Massette antieffilement angles abattus avec manche en bois Mix

COD. ART.	Gr.	L mm	BOX	COD. EAN - 13
MM 800 L/MIX	800	270	6	80 3264633 233 9
MM 1000 L/MIX	1000	270	6	80 3264633 234 6
MM 1250 L/MIX	1250	270	6	80 3264633 277 3
MM 1500 L/MIX	1500	270	6	80 3264633 314 5
MM 2000 L/MIX	2000	270	6	80 3264633 007 6

Mercato / Markets / Marchés



**Mazzetta antisfilamento con manico in legno**

Anti-unthreading club hammer with wooden handle  
Massette antieffilement angles abattus avec manche en bois

COD. ART.	Gr.	L mm	BOX	COD. EAN - 13
MM 800 LE	800	280	6	80 3264633 334 3
MM 1000 LE	1000	280	6	80 3264633 335 0
MM 1250 LE	1250	280	6	80 3264633 336 7
MM 1500 LE	1500	280	6	80 3264633 337 4
MM 2000 LE	2000	280	6	80 3264633 338 1

Mercato / Markets / Marchés



**Mazzetta con manico in legno linea TOP Din 6475**

Club hammer with TOP wooden handle Din 6475  
Massette angles abattus avec manche bois TOP Din 6475

COD. ART.	Gr.	L mm	BOX	COD. EAN - 13
MD 800 TOP	800	265	6	80 3264633 803 4
MD 1000 TOP	1000	265	6	80 3264633 804 1
MD 1200 TOP	1250	270	6	80 3264633 805 8
MD 1500 TOP	1500	270	6	80 3264633 806 5
MD 2000 TOP	2000	270	6	80 3264633 807 2

Mercato / Markets / Marchés



**Mazzetta con manico in legno Din 6475**

Club hammer with wooden handle Din 6475  
Massette angles abattus avec manche bois Din 6475

COD. ART.	Gr.	L mm	BOX	COD. EAN - 13
MD 800 LE	800	265	6	80 3264633 808 9
MD 1000 LE	1000	265	6	80 3264633 809 6
MD 1200 LE	1250	270	6	80 3264633 810 2
MD 1500 LE	1500	270	6	80 3264633 811 9
MD 2000 LE	2000	270	6	80 3264633 812 6



Mercato / Markets / Marchés



### Mazzuola in gomma nera con manico in legno antisfilamento

Black rubber mallets with wooden handle  
Maillets en caoutchouc noir avec manche en bois

COD. ART.	Gr.	L mm	BOX	COD. EAN - 13
MGN 300 LE	300	50	6	80 5773372 744 7
MGN 500 LE	500	60	6	80 5773372 745 4
MGN 800 LE	800	70	6	80 5773372 746 1



Mercato / Markets / Marchés  



### Mazzuole in gomma bianca con manico in legno antisfilamento

White rubber mallets with wooden handle  
Maillets en caoutchouc blanc avec manche en bois

COD. ART.	Gr.	L mm	BOX	COD. EAN - 13
MGB 300 LE	300	50	6	80 5773372 747 8
MGB 500 LE	500	60	6	80 5773372 748 5
MGB 800 LE	800	70	6	80 5773372 749 2

Mercato / Markets / Marchés  

MARTELLERIA 4

MAZZE e PICCONI 20

SCALPELLI e LEVERINI 24

ARTICOLI PER PIETRA 26

SECCHI, CAZZUOLE, SPATOLE e VARIE 27

BADILI, PALE, RASCHIETTI e RASCHIAFANGO 39

ACCETTE, PICOZZINI, RONCOLE e MACETE 52

ASCE, MAZZESCURI e CUNEI 55

RASTRELLI, SARCHIATORI e AERATORI 61

SCOPE FOGLIE 69

RACCOLTA FRUTTA e TRATTAMENTO 78

NOVITÀ 84

FORCHE e VANGHE 90

ZAPPE, ZAPPINI, ATTREZZINI e FORBICI 94

MANICI FIBRA 101

MANICI MIX e LEGNO 115

ASTE TELESCOPICHE 123

ESPOSITORI 124

GUANTI 126



SOLLEVAMENTO e ANCORAGGIO 140

- 4 MARTELLERIA
- 20 MAZZE e PICCONI
- 24 SCALPELLI e LEVERINI
- 26 ARTICOLI PER PIETRA
- 27 SECCHI, CAZZUOLE, SPATOLE e VARIE
- 39 BADILI, PALE, RASCHIETTI e RASCHIAFANGO
- 52 ACCETTE, PICOZZINI, RONCOLE e MACETE
- 55 ASCE, MAZZESCURI e CUNEI
- 61 RASTRELLI, SARCHIATORI e AERATORI
- 69 SCOPE FOGLIE
- 78 RACCOLTA FRUTTA e TRATTAMENTO
- 84 NOVITÀ
- 90 FORCHE e VANGHE
- 94 ZAPPE, ZAPPINI, ATTREZZINI e FORBICI
- 101 MANICI FIBRA
- 115 MANICI MIX e LEGNO
- 123 ASTE TELESCOPICHE
- 124 ESPOSITORI
- 126 GUANTI
- 140 SOLLEVAMENTO e ANCORAGGIO

### Mazzetta in rame con manico in legno linea TOP

Copper club hammer with TOP wooden handle  
Massette en cuivre avec manche en bois TOP

COD. ART.	Gr.	L mm	BOX	COD. EAN - 13
<b>MR 300 TOP</b>	300	260	1	80 5773372 118 6
<b>MR 500 TOP</b>	500	300	1	80 5773372 119 3
<b>MR 800 TOP</b>	800	330	1	80 5773372 120 9
<b>MR 1000 TOP</b>	1000	330	1	80 5773372 121 6



Mercato / Markets / Marchés  



### Martello a granchio con manico in legno

Nail hammer with wooden handle  
Marteau bourgeois avec manche en bois

COD. ART.	Gr.	L mm	BOX	COD. EAN - 13
<b>MGR 200 LE</b>	200	270	6	80 5773372 122 3
<b>MGR 300 LE</b>	300	285	6	80 5773372 123 0
<b>MGR 400 LE</b>	400	300	6	80 5773372 124 7

Mercato / Markets / Marchés  



### Martello da banco tipo tedesco con manico anima in fibra di vetro (impugnatura in gomma)

Machinist's hammer, German model with patented glass fibre core handle (rubber haft) DIN 1041  
 Marteau mecanicien, modèle allemand avec manche trimatière brevete DIN 1041

COD. ART.	Gr.	L mm	BOX	COD. EAN - 13
MBT 2720 G	200	270	6	80 3264633 721 1
MBT 2730 G	300	270	6	80 3264633 191 2
MBT 2740 G	400	270	6	80 3264633 192 9
MBT 2850 G	500	280	6	80 3264633 193 6
MBT 2860 G	600	280	6	80 3264633 194 3
MBT 3180 G	800	310	6	80 3264633 195 0
MBT 31100 G	1000	310	6	80 3264633 196 7

Mercato / Markets / Marchés

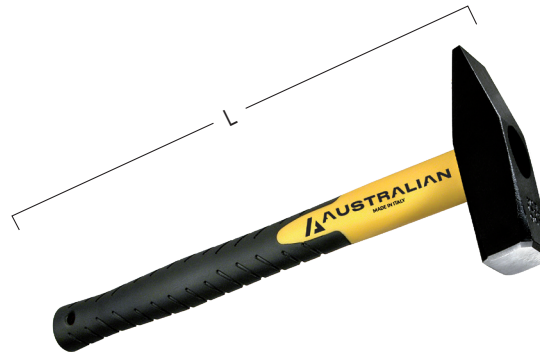

### Martello da banco tipo tedesco con manico in legno linea TOP

Machinist's hammer, German model with TOP wooden handle  
 Marteau mecanicien, modèle allemand avec manche en bois qualité TOP

COD. ART.	Gr.	L mm	BOX	COD. EAN - 13
MBT 100 TOP	100	265	6	80 3264633 722 8
MBT 200 TOP	200	280	6	80 3264633 753 2
MBT 300 TOP	300	300	6	80 3264633 754 9
MBT 400 TOP	400	310	6	80 3264633 755 6
MBT 500 TOP	500	320	6	80 3264633 756 3
MBT 600 TOP	600	335	6	80 3264633 757 0
MBT 800 TOP	800	350	6	80 3264633 758 7
MBT 1000 TOP	1000	360	6	80 3264633 759 4
MBT 1500 TOP	1500	380	6	80 3264633 760 0
MBT 2000 TOP	2000	400	6	80 3264633 761 7

Mercato / Markets / Marchés



### Martello da banco tipo tedesco con manico in legno

Machinist's hammer, German model with wooden handle  
 Marteau mecanicien, modèle allemand avec manche en bois qualité

COD. ART.	Gr.	L mm	BOX	COD. EAN - 13
MBT 100 LE	100	265	6	80 3264633 762 4
MBT 200 LE	200	280	6	80 3264633 763 1
MBT 300 LE	300	300	6	80 3264633 764 8
MBT 400 LE	400	310	6	80 3264633 765 5
MBT 500 LE	500	320	6	80 3264633 766 2
MBT 600 LE	600	335	6	80 3264633 767 9
MBT 800 LE	800	350	6	80 3264633 768 6
MBT 1000 LE	1000	360	6	80 3264633 769 3
MBT 1500 LE	1500	380	6	80 3264633 770 9
MBT 2000 LE	2000	400	6	80 3264633 771 6

Mercato / Markets / Marchés



MARTELLERIA

4

MAZZE e PICCONI

20

SCALPELLI e LEVERINI

24

ARTICOLI PER PIETRA

26

SECCHI, CAZZUOLE, SPATOLE e VARIE

27

BADILI, PALE, RASCHIETTI e RASCHIAFANGO

39

ACCETTE, PICOZZINI, RONCOLE e MACETE

52

ASCE, MAZZESCURI e CUNEI

55

RASTRELLI, SARCHIATORI e AERATORI

61

SCOPE FOGLIE

69

RACCOLTA FRUTTA e TRATTAMENTO

78

NOVITÀ

84

FORCHE e VANGHE

90

ZAPPE, ZAPPINI, ATTREZZINI e FORBICI

94

MANICI FIBRA

101

MANICI MIX e LEGNO

115

ASTE TELESCOPICHE

123

ESPOSITORI

124

GUANTI

126

SOLLEVAMENTO e ANCORAGGIO

140

- 4 MARTELLERIA
- 20 MAZZE e PICCONI
- 24 SCALPELLI e LEVERINI
- 26 ARTICOLI PER PIETRA
- 27 SECCHI, CAZZUOLE, SPATOLE e VARIE
- 39 BADILI, PALE, RASCHIETTI e RASCHIAFANGO
- 52 ACCETTE, PICOZZINI, RONCOLE e MACETE
- 55 ASCE, MAZZESCURI e CUNEI
- 61 RASTRELLI, SARCHIATORI e AERATORI
- 69 SCOPE FOGLIE
- 78 RACCOLTA FRUTTA e TRATTAMENTO
- 84 NOVITÀ
- 90 FORCHE e VANGHE
- 94 ZAPPE, ZAPPINI, ATTREZZINI e FORBICI
- 101 MANICI FIBRA
- 115 MANICI MIX e LEGNO
- 123 ASTE TELESCOPICHE
- 124 ESPOSITORI
- 126 GUANTI
- 140 SOLLEVAMENTO e ANCORAGGIO

### Martello fabbro tipo francese con manico anima in fibra di vetro (impugnatura in gomma)

Locksmith's hammer French pattern with glass fibre core handle (rubber haft)  
 Marteau rivoir avec manche trimatière

COD. ART.	H mm	Gr.	L mm	BOX	COD. EAN - 13
<b>MBF 22 G</b>	22	200	290	6	80 3264633 751 8
<b>MBF 25 G</b>	25	260	295	6	80 3264633 752 5
<b>MBF 30 G</b>	30	380	310	6	80 3264633 772 3
<b>MBF 35 G</b>	35	600	345	6	80 3264633 773 0
<b>MBF 40 G</b>	40	800	350	6	80 3264633 774 7

Mercato / Markets / Marchés



### Martello fabbro tipo francese con manico in legno linea TOP

Locksmith's hammer French pattern, with TOP wooden handle  
 Marteau rivoir avec manche en bois qualité TOP

COD. ART.	H mm	Gr.	L mm	BOX	COD. EAN - 13
<b>MBF 18 TOP</b>	18	100	265	6	80 3264633 775 4
<b>MBF 22 TOP</b>	22	200	280	6	80 3264633 776 1
<b>MBF 25 TOP</b>	25	260	300	6	80 3264633 777 8
<b>MBF 28 TOP</b>	28	320	310	6	80 3264633 778 5
<b>MBF 30 TOP</b>	30	380	320	6	80 3264633 779 2
<b>MBF 35 TOP</b>	35	600	320	6	80 3264633 780 8
<b>MBF 40 TOP</b>	40	800	350	6	80 3264633 781 5
<b>MBF 45 TOP</b>	45	1000	380	6	80 3264633 782 2
<b>MBF 50 TOP</b>	50	1500	380	6	80 3264633 106 6
<b>MBF 55 TOP</b>	55	2000	400	6	80 3264633 111 0

Mercato / Markets / Marchés



### Martello fabbro tipo francese con manico in legno

Locksmith's hammer French pattern, with wooden handle  
 Marteau rivoir avec manche en bois qualité

COD. ART.	H mm	Gr.	L mm	BOX	COD. EAN - 13
<b>MBF 18 LE</b>	18	100	265	6	80 3264633 783 9
<b>MBF 22 LE</b>	22	200	280	6	80 3264633 784 6
<b>MBF 25 LE</b>	25	260	300	6	80 3264633 785 3
<b>MBF 28 LE</b>	28	320	310	6	80 3264633 786 0
<b>MBF 30 LE</b>	30	380	320	6	80 3264633 787 7
<b>MBF 35 LE</b>	35	600	320	6	80 3264633 788 4
<b>MBF 40 LE</b>	40	800	350	6	80 3264633 789 1
<b>MBF 45 LE</b>	45	1000	380	6	80 3264633 790 7
<b>MBF 50 LE</b>	50	1500	380	6	80 3264633 153 0
<b>MBF 55 LE</b>	55	2000	400	6	80 3264633 168 4

Mercato / Markets / Marchés







**Martello falegname a penna lunga con manico anima FV (impugnatura in gomma)**

Joiner's hammer with glass fibre core handle (rubber haft)  
 Marteau de menuisier avec manche trimatière

COD. ART.	H mm	Gr.	L mm	BOX	COD. EAN - 13
MFF 20 G	20	160	290	6	80 3264633 791 4
MFF 25 G	25	300	300	6	80 3264633 792 1
MFF 30 G	30	500	340	6	80 3264633 793 8

Mercato / Markets / Marchés



**Martello elettricista penna lunga con manico anima in fibra di vetro (impugnatura in gomma)**

Electrician's hammer, with glass fibre core handle (rubber haft)  
 Marteau électricien avec manche trimatière

COD. ART.	H mm	Gr.	L mm	BOX	COD. EAN - 13
MEF 18 G	18	200	285	6	80 3264633 800 3

Mercato / Markets / Marchés



**Martello falegname a penna lunga con manico in legno linea TOP**

Joiner's hammer with TOP wooden handle  
 Marteau de menuisier avec manche en bois qualité TOP

COD. ART.	H mm	Gr.	L mm	BOX	COD. EAN - 13
MF 20 TOP	20	160	265	6	80 3264633 794 5
MF 25 TOP	25	300	300	6	80 3264633 795 2
MF 30 TOP	30	500	320	6	80 3264633 796 9

Mercato / Markets / Marchés



**Martello elettricista penna lunga con manico in legno linea TOP**

Electrician's hammer, with TOP wooden handle  
 Marteau électricien avec manche en bois qualité TOP

COD. ART.	H mm	Gr.	L mm	BOX	COD. EAN - 13
MEF 18 TOP	18	200	265	6	80 3264633 801 0

Mercato / Markets / Marchés



**Martello falegname a penna lunga con manico in legno**

Joiner's hammer with wooden handle  
 Marteau de menuisier avec manche en bois qualité

COD. ART.	H mm	Gr.	L mm	BOX	COD. EAN - 13
MF 20 LE	20	160	265	6	80 3264633 797 6
MF 25 LE	25	300	300	6	80 3264633 798 3
MF 30 LE	30	500	320	6	80 3264633 799 0

Mercato / Markets / Marchés



**Martello elettricista a penna lunga con manico in legno**

Electrician's hammer, with wooden handle  
 Marteau électricien avec manche en bois qualité

COD. ART.	H mm	Gr.	L mm	BOX	COD. EAN - 13
MEF 18 LE	18	200	265	6	80 3264633 802 7

Mercato / Markets / Marchés

MARTELLERIA

4

MAZZE e PICCONI

20

SCALPELLI e LEVERINI

24

ARTICOLI PER PIETRA

26

SECCHI, CAZZUOLE, SPATOLE e VARIE

27

BADILI, PALE, RASCHIETTI e RASCHIAFANGO

39

ACCETTE, PICOZZINI, RONCOLE e MACETE

52

ASCE, MAZZESCURI e CUNEI

55

RASTRELLI, SARCHIATORI e AERATORI

61

SCOPE FOGLIE

69

RACCOLTA FRUTTA e TRATTAMENTO

78

NOVITÀ

84

FORCHE e VANGHE

90

ZAPPE, ZAPPINI, ATTREZZINI e FORBICI

94

MANICI FIBRA

101

MANICI MIX e LEGNO

115

ASTE TELESCOPICHE

123

ESPOSITORI

124

GUANTI

126

SOLLEVAMENTO e ANCORAGGIO

140

4 MARTELLERIA

20 MAZZE e PICCONI

24 SCALPELLI e LEVERINI

26 ARTICOLI PER PIETRA

27 SECCHI, CAZZUOLE, SPATOLE e VARIE

39 BADILI, PALE, RASCHIETTI e RASCHIAFANGO

52 ACCETTE, PICOZZINI, RONCOLE e MACETE

55 ASCE, MAZZESCURI e CUNEI

61 RASTRELLI, SARCHIATORI e AERATORI

69 SCOPE FOGLIE

78 RACCOLTA FRUTTA e TRATTAMENTO

84 NOVITÀ

90 FORCHE e VANGHE

94 ZAPPE, ZAPPINI, ATTREZZINI e FORBICI

101 MANICI FIBRA

115 MANICI MIX e LEGNO

123 ASTE TELESCOPICHE

124 ESPOSITORI

126 GUANTI

140 SOLLEVAMENTO e ANCORAGGIO



**Martello carpentiere manico anima in fibra di vetro (impugnatura in gomma)**

Carpenter's hammer with glass fibre core handle (rubber haft)  
 Marteau coffreur modèle italien avec manche trimatière

COD. ART.	Gr.	L mm	BOX	COD. EAN - 13
CF 4525 G	250	450	6	80 3264633 085 4
CF 5025 G	250	500	6	80 3264633 086 1
CF 5825 G	250	580	6	80 3264633 087 8
CF 4530 G	300	450	6	80 3264633 088 5
CF 5030 G	300	500	6	80 3264633 089 2
CF 5830 G	300	580	6	80 3264633 090 8
CF 4540 G	400	450	6	80 3264633 091 5
CF 5040 G	400	500	6	80 3264633 092 2
CF 4550 G	500	450	6	80 3264633 093 9

Mercato / Markets / Marchés



**Martello carpentiere con calamita manico anima in fibra di vetro (impugnatura in gomma)**

Carpenter's hammer with glass fibre core handle (rubber haft) and magnet  
 Marteau coffreur modèle italien avec manche trimatière et aimanté

COD. ART.	Gr.	L mm	BOX	COD. EAN - 13
CCF 4525 G	250	450	6	80 3264633 094 6
CCF 5025 G	250	500	6	80 3264633 095 3
CCF 5825 G	250	580	6	80 3264633 096 0
CCF 4530 G	300	450	6	80 3264633 097 7
CCF 5030 G	300	500	6	80 3264633 098 4
CCF 5830 G	300	580	6	80 3264633 099 1
CCF 4540 G	400	450	6	80 3264633 100 4
CCF 5040 G	400	500	6	80 3264633 101 1
CCF 4550 G	500	450	6	80 3264633 169 1

Mercato / Markets / Marchés



**Martello carpentiere con manico in legno Mix**

Carpenter's hammer with wooden handle Mix  
 Marteau coffreur modèle italien avec manche en bois Mix

COD. ART.	Gr.	L mm	BOX	COD. EAN - 13
CF 4525 L/MIX	250	450	6	80 3264633 167 7
CF 6025 L/MIX	250	600	6	80 3264633 357 2
CF 4530 L/MIX	300	450	6	80 3264633 208 7
CF 6030 L/MIX	300	600	6	80 3264633 358 9
CF 4540 L/MIX	400	450	6	80 3264633 172 1
CF 4550 L/MIX	500	450	6	80 3264633 360 2

Mercato / Markets / Marchés



**Martello carpentiere con calamita manico in legno Mix**

Carpenter's hammer with magnet and wooden handle Mix  
 Marteau coffreur modèle italien aimanté et manche en bois Mix

COD. ART.	Gr.	L mm	BOX	COD. EAN - 13
CCF 4525 L/MIX	250	450	6	80 3264633 262 9
CCF 6025 L/MIX	250	600	6	80 3264633 244 5
CCF 4530 L/MIX	300	450	6	80 3264633 237 7
CCF 6030 L/MIX	300	600	6	80 3264633 355 8
CCF 4540 L/MIX	400	450	6	80 3264633 016 8
CCF 4550 L/MIX	500	450	6	80 3264633 258 2

Mercato / Markets / Marchés



**Martello carpentiere manico frassino verniciato**

Carpenter's hammer with painted ash wood handle  
 Marteau coffreur italien manche en bois de frene verni

COD. ART.	Gr.	L mm	BOX	COD. EAN - 13
CF 4525 LFV	250	450	6	80 5773372 043 1
CF 6025 LFV	250	600	6	80 5773372 044 8
CF 4530 LFV	300	450	6	80 5773372 045 5
CF 6030 LFV	300	600	6	80 5773372 046 2
CF 4540 LFV	400	450	6	80 5773372 047 9
CF 4550 LFV	500	450	6	80 5773372 048 6

Mercato / Markets / Marchés



**Martello carpentiere con calamita manico frassino verniciato**

Carpenter's hammer with magnet and painted ash wood handle  
 Marteau coffreur italien manche en bois de frene verni

COD. ART.	Gr.	L mm	BOX	COD. EAN - 13
CCF 4525 LFV	250	450	6	80 5773372 037 0
CCF 6025 LFV	250	600	6	80 5773372 038 7
CCF 4530 LFV	300	450	6	80 5773372 039 4
CCF 6030 LFV	300	600	6	80 5773372 040 0
CCF 4540 LFV	400	450	6	80 5773372 041 7
CCF 4550 LFV	500	450	6	80 5773372 042 4

Mercato / Markets / Marchés



**Martello carpentiere manico in legno**

Carpenter's hammer with wooden handle  
 Marteau coffreur modèle italien avec manche en bois

COD. ART.	Gr.	L mm	BOX	COD. EAN - 13
CF 4525 LE	250	450	6	80 3264633 051 9
CF 6025 LE	250	600	6	80 3264633 288 9
CF 4530 LE	300	450	6	80 3264633 290 2
CF 6030 LE	300	600	6	80 3264633 024 3
CF 4540 LE	400	450	6	80 3264633 292 6
CF 4550 LE	500	450	6	80 3264633 381 7

Mercato / Markets / Marchés



**Martello carpentiere con calamita manico in legno**

Carpenter's hammer with magnet and wooden handle  
 Marteau coffreur modèle italien aimanté et manche en bois

COD. ART.	Gr.	L mm	BOX	COD. EAN - 13
CCF 4525 LE	250	450	6	80 3264633 008 3
CCF 6025 LE	250	600	6	80 3264633 012 0
CCF 4530 LE	300	450	6	80 3264633 291 9
CCF 6030 LE	300	600	6	80 3264633 021 2
CCF 4540 LE	400	450	6	80 3264633 293 3
CCF 4550 LE	500	450	6	80 3264633 404 3

Mercato / Markets / Marchés

MARTELLERIA 4

MAZZE e PICCONI 20

SCALPELLI e LEVERINI 24

ARTICOLI PER PIETRA 26

SECCHI, CAZZUOLE, SPATOLE e VARIE 27

BADILI, PALE, RASCHIETTI e RASCHIAFANGO 39

ACCETTE, PICOZZINI, RONCOLE e MACETE 52

ASCE, MAZZESCURI e CUNEI 55

RASTRELLI, SARCHIATORI e AERATORI 61

SCOPE FOGLIE 69

RACCOLTA FRUTTA e TRATTAMENTO 78

NOVITÀ 84

FORCHE e VANGHE 90

ZAPPE, ZAPPINI, ATTREZZINI e FORBICI 94

MANICI FIBRA 101

MANICI MIX e LEGNO 115

ASTE TELESCOPICHE 123

ESPOSITORI 124

GUANTI 126

SOLLEVAMENTO e ANCORAGGIO 140

4 MARTELLERIA

20 MAZZE e PICCONI

24 SCALPELLI e LEVERINI

26 ARTICOLI PER PIETRA

27 SECCHI, CAZZUOLE, SPATOLE e VARIE

39 BADILI, PALE, RASCHIETTI e RASCHIAFANGO

52 ACCETTE, PICOZZINI, RONCOLE e MACETE

55 ASCE, MAZZESCURI e CUNEI

61 RASTRELLI, SARCHIATORI e AERATORI

69 SCOPE FOGLIE

78 RACCOLTA FRUTTA e TRATTAMENTO

84 NOVITÀ

90 FORCHE e VANGHE

94 ZAPPE, ZAPPINI, ATTREZZINI e FORBICI

101 MANICI FIBRA

115 MANICI MIX e LEGNO

123 ASTE TELESCOPICHE

124 ESPOSITORI

126 GUANTI

140 SOLLEVAMENTO e ANCORAGGIO



**BECCO ROSSO SPECIALE BENNE TEMPERATE**  
**Martello carpentiere con calamita manico anima in fibra di vetro (impugnatura in gomma)**

RED BILL SPECIAL HARDENED PEENS Carpenter's hammer with glass fibre core handle (rubber haft) and magnet  
 BEC ROUGE SPECIAL PANNES TREMPES Marteau coffreur modèle italien avec manche trimatiè et aimanté

COD. ART.	Gr.	L mm	BOX	COD. EAN - 13
R_CCF4525G	250	450	6	80 3264633 158 5
R_CCF5025G	250	500	6	80 3264633 353 4
R_CCF5825G	250	580	6	80 3264633 151 6
R_CCF4530G	300	450	6	80 3264633 152 3
R_CCF5030G	300	500	6	80 3264633 356 5
R_CCF5830G	300	580	6	80 3264633 154 7
R_CCF4540G	400	450	6	80 3264633 155 4

Mercato / Markets / Marchés



**BECCO ROSSO SPECIALE BENNE TEMPERATE**  
**Martello carpentiere con calamita manico in legno Mix**

RED BILL SPECIAL HARDENED PEENS  
 Carpenter's hammer with magnet and wooden handle Mix  
 BEC ROUGE SPECIAL PANNES TREMPES  
 Marteau coffreur modèle italien aimanté et manche en bois Mix

COD. ART.	Gr.	L mm	BOX	COD. EAN - 13
R_CCF4525L/MIX	250	450	6	80 3264633 164 6
R_CCF6025L/MIX	250	600	6	80 3264633 487 6
R_CCF4530L/MIX	300	450	6	80 3264633 014 4
R_CCF6030L/MIX	300	500	6	80 3264633 299 5
R_CCF4540L/MIX	400	450	6	80 3264633 083 0

Mercato / Markets / Marchés



**Martello carpentiere Catania manico anima FV (impugnatura in gomma)**

Catania carpenter hammer with glass fibre core handle (rubber haft)  
 Marteau coffreur Catania avec manche trimatière

COD. ART.	Gr.	L mm	BOX	COD. EAN - 13
CT 4520 G	200	450	6	80 5773372 051 6

Mercato / Markets / Marchés



**Martello carpentiere Catania con manico in legno Mix**

Catania carpenter hammer with wooden handle Mix  
 Marteau coffreur Catania avec manche en bois Mix

COD. ART.	Gr.	L mm	BOX	COD. EAN - 13
CT 4520 L/MIX	200	450	6	80 5773372 050 9

Mercato / Markets / Marchés



**Martello carpentiere Catania manico in frassino verniciato**

Catania carpenter hammer with painted ash wood handle  
 Marteau coffreur Catania manche en bois de frene verni

COD. ART.	Gr.	L mm	BOX	COD. EAN - 13
CT 4520 Lfv	200	450	6	80 5773372 049 3

Mercato / Markets / Marchés



**Martello carpentiere francese manico anima FV (impugnatura in gomma)**

French carpenter hammer with glass fibre core handle (rubber haft)  
 Marteau coffreur français avec manche trimatière

COD. ART.	Gr.	L mm	BOX	COD. EAN - 13
CF 3770 G	700	370	6	80 3264633 102 8
Mercato / Markets / Marchés				



**Martello carpentiere francese c/cal manico anima FV (impugnatura in gomma)**

French carpenter hammer w/magnet and glass fibre core handle (rubber haft)  
 Marteau coffreur français aimanté avec manche trimatière

COD. ART.	Gr.	L mm	BOX	COD. EAN - 13
CCF 3770 G	700	370	6	80 3264633 103 5
Mercato / Markets / Marchés				



**Martello carpentiere francese con manico in legno Mix**

French carpenter hammer with wooden handle Mix  
 Marteau coffreur français avec manche en bois Mix

COD. ART.	Gr.	L mm	BOX	COD. EAN - 13
CF 3770 L/MIX	700	370	6	80 3264633 361 9
Mercato / Markets / Marchés				



**Martello carpentiere francese con calamita manico in legno Mix**

French carpenter hammer with magnet and with wooden handle Mix  
 Marteau coffreur français aimanté avec manche en bois Mix

COD. ART.	Gr.	L mm	BOX	COD. EAN - 13
CCF 3770 L/MIX	700	370	6	80 3264633 362 6
Mercato / Markets / Marchés				



**Martello carpentiere francese manico in frassino verniciato**

French carpenter hammer with painted ash wood handle  
 Marteau coffreur français manche en bois de frene verni

COD. ART.	Gr.	L mm	BOX	COD. EAN - 13
CF 3770 LFV	700	370	6	80 5773372 053 0
Mercato / Markets / Marchés				



**Martello carpentiere francese c/cal. man. frassino verniciato**

French carpenter hammer w/magnet and with painted ash wood handle  
 Marteau coffreur français aimanté manche en bois de frene verni

COD. ART.	Gr.	L mm	BOX	COD. EAN - 13
CCF 3770 LFV	700	370	6	80 5773372 052 3
Mercato / Markets / Marchés				



**Martello carpentiere francese con manico in legno**

French carpenter hammer with wooden handle  
 Marteau coffreur français avec manche en bois

COD. ART.	Gr.	L mm	BOX	COD. EAN - 13
CF 3770 LE	700	370	6	80 3264633 363 3
Mercato / Markets / Marchés				



**Martello carpentiere francese con calamita manico in legno**

French carpenter hammer with magnet and with wooden handle  
 Marteau coffreur français aimanté avec manche en bois

COD. ART.	Gr.	L mm	BOX	COD. EAN - 13
CCF 3770 LE	700	370	6	80 3264633 364 0
Mercato / Markets / Marchés				

MARTELLERIA

4

MAZZE e PICCONI

20

SCALPELLI e LEVERINI

24

ARTICOLI PER PIETRA

26

SECCHI, CAZZUOLE, SPATOLE e VARIE

27

BADILI, PALE, RASCHIETTI e RASCHIAFANGO

39

ACCETTE, PICOZZINI, RONCOLE e MACETE

52

ASCE, MAZZESCURI e CUNEI

55

RASTRELLI, SARCHIATORI e AERATORI

61

SCOPE FOGLIE

69

RACCOLTA FRUTTA e TRATTAMENTO

78

NOVITÀ

84

FORCHE e VANGHE

90

ZAPPE, ZAPPINI, ATTREZZINI e FORBICI

94

MANICI FIBRA

101

MANICI MIX e LEGNO

115

ASTE TELESCOPICHE

123

ESPOSITORI

124

GUANTI

126

SOLLEVAMENTO e ANCORAGGIO

140

4 MARTELLERIA

20 MAZZE e PICCONI

24 SCALPELLI e LEVERINI

26 ARTICOLI PER PIETRA

27 SECCHI, CAZZUOLE, SPATOLE e VARIE

39 BADILI, PALE, RASCHIETTI e RASCHIAFANGO

52 ACCETTE, PICOZZINI, RONCOLE e MACETE

55 ASCE, MAZZESCURI e CUNEI

61 RASTRELLI, SARCHIATORI e AERATORI

69 SCOPE FOGLIE

78 RACCOLTA FRUTTA e TRATTAMENTO

84 NOVITÀ

90 FORCHE e VANGHE

94 ZAPPE, ZAPPINI, ATTREZZINI e FORBICI

101 MANICI FIBRA

115 MANICI MIX e LEGNO

123 ASTE TELESCOPICHE

124 ESPOSITORI

126 GUANTI

140 SOLLEVAMENTO e ANCORAGGIO

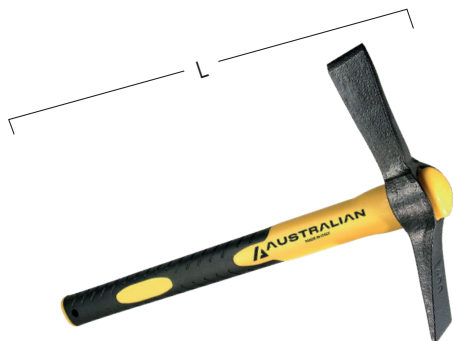

**Martellina Malepeggio manico anima in fibra di vetro (impugnatura in gomma)**

Chipping hammer with glass fibre core handle (rubber haft)  
Décintroir à hache avec manche trimatière

COD. ART.	Gr.	L mm	BOX	COD. EAN - 13
A40 MA 300 G	300	390	6	80 5773372 759 1
A40 MA 400 G	400	390	6	80 3264633 176 9
A40 MA 500 G	500	390	6	80 3264633 104 2
Mercato / Markets / Marchés				



**Martellina Malepeggio con manico in legno Mix**

Chipping hammer with wooden handle Mix  
Décintroir à hache avec manche en bois Mix

COD. ART.	Gr.	L mm	BOX	COD. EAN - 13
A38 MA 300 L/MIX	300	370	6	80 5773372 760 7
A38 MA 400 L/MIX	400	370	6	80 3264633 245 2
A38 MA 500 L/MIX	500	370	6	80 3264633 044 1
Mercato / Markets / Marchés				



**Martellina Malepeggio manico frassino verniciato**

Chipping hammer with painted ash wood handle  
Décintroir à hache avec manche en bois de frêne verni

COD. ART.	Gr.	L mm	BOX	COD. EAN - 13
A38 MA 300 LFV	300	370	6	80 5773372 761 4
A38 MA 400 LFV	400	370	6	80 5773372 054 7
A38 MA 500 LFV	500	370	6	80 5773372 055 4
Mercato / Markets / Marchés				



**Martellina Malepeggio con manico in legno**

Chipping hammer with wooden handle Mix  
Décintroir à hache avec manche en bois Mix



COD. ART.	Gr.	L mm	BOX	COD. EAN - 13
A38 MA 300 LE	300	370	6	80 5773372 762 1
A38 MA 400 LE	400	370	6	80 3264633 294 0
A38 MA 500 LE	500	370	6	80 3264633 140 0
Mercato / Markets / Marchés				



**Martellina Catania manico anima in fibra di vetro (impugnatura in gomma)**

Little pickaxe Catania with glass fibre core handle (rubber haft)  
 Décintoir à pic avec manche trimatière

COD. ART.	Gr.	L mm	BOX	COD. EAN - 13
MC 4040 G	400	390	6	80 3264633 198 1
MC 4050 G	500	390	6	80 3264633 146 2



Mercato / Markets / Marchés  



**Martellina Catania con manico in legno Mix**

Little pickaxe Catania with wooden handle Mix  
 Décintoir à pic avec manche en bois Mix

COD. ART.	Gr.	L mm	BOX	COD. EAN - 13
MC 3840 L/MIX	400	370	6	80 3264633 289 6
MC 3850 L/MIX	500	370	6	80 3264633 156 1



Mercato / Markets / Marchés  



**Martellina Catania con manico in frassino verniciato**

Little pickaxe Catania with painted ash wood handle  
 Décintoir à pic avec manche en bois de frene verni

COD. ART.	Gr.	L mm	BOX	COD. EAN - 13
MC 3840 LfV	400	370	6	80 3264633 645 0
MC 3850 LfV	500	370	6	80 5773372 056 1



Mercato / Markets / Marchés  



**Martellina Catania con manico in legno**

Little pickaxe Catania with wooden handle  
 Décintoir à pic avec manche en bois

COD. ART.	Gr.	L mm	BOX	COD. EAN - 13
MC 3840 LE	400	370	6	80 3264633 296 4
MC 3850 LE	500	370	6	80 3264633 170 7

Mercato / Markets / Marchés  

MARTELLERIA 4

MAZZE e PICCONI 20

SCALPELLI e LEVERINI 24

ARTICOLI PER PIETRA 26

SECCHI, CAZZUOLE, SPATOLE e VARIE 27

BADILI, PALE, RASCHIETTI e RASCHIAFANGO 39

ACCETTE, PICOZZINI, RONCOLE e MACETE 52

ASCE, MAZZESCURI e CUNEI 55

RASTRELLI, SARCHIATORI e AERATORI 61

SCOPE FOGLIE 69

RACCOLTA FRUTTA e TRATTAMENTO 78

NOVITÀ 84

FORCHE e VANGHE 90

ZAPPE, ZAPPINI, ATTREZZINI e FORBICI 94

MANICI FIBRA 101

MANICI MIX e LEGNO 115

ASTE TELESCOPICHE 123

ESPOSITORI 124

GUANTI 126

SOLLEVAMENTO e ANCORAGGIO 140

- 4 MARTELLERIA
- 20 MAZZE e PICCONI
- 24 SCALPELLI e LEVERINI
- 26 ARTICOLI PER PIETRA
- 27 SECCHI, CAZZUOLE, SPATOLE e VARIE
- 39 BADILI, PALE, RASCHIETTI e RASCHIAFANGO
- 52 ACCETTE, PICOZZINI, RONCOLE e MACETE
- 55 ASCE, MAZZESCURI e CUNEI
- 61 RASTRELLI, SARCHIATORI e AERATORI
- 69 SCOPE FOGLIE
- 78 RACCOLTA FRUTTA e TRATTAMENTO
- 84 NOVITÀ
- 90 FORCHE e VANGHE
- 94 ZAPPE, ZAPPINI, ATTREZZINI e FORBICI
- 101 MANICI FIBRA
- 115 MANICI MIX e LEGNO
- 123 ASTE TELESCOPICHE
- 124 ESPOSITORI
- 126 GUANTI
- 140 SOLLEVAMENTO e ANCORAGGIO



### Martello muratore con manico anima in fibra di vetro (impugnatura in gomma)

Mason's hammer with glass fibre core handle (rubber haft)  
 Martelette à briques avec manche trimatière

COD. ART.	Gr.	L mm	BOX	COD. EAN - 13
MU 4040 G	400	390	6	80 3264633 260 5
MU 4060 G	600	390	6	80 3264633 197 4
Mercato / Markets / Marchés				



### Martello muratore con manico in legno Mix

Mason's hammer with wooden handle Mix  
 Martelette à briques avec manche en bois Mix

COD. ART.	Gr.	L mm	BOX	COD. EAN - 13
MU 3840 L/MIX	400	370	6	80 3264633 246 9
MU 3860 L/MIX	600	370	6	80 3264633 365 7
Mercato / Markets / Marchés				



### Martello muratore manico in frassino verniciato

Mason's hammer with painted ash wood handle  
 Martelette à briques avec manche en bois de frene verni

COD. ART.	Gr.	L mm	BOX	COD. EAN - 13
MU 3840 LfV	400	370	6	80 3264633 644 3
MU 3860 LfV	600	370	6	80 5773372 057 8
Mercato / Markets / Marchés				



### Martello muratore con manico in legno

Mason's hammer with wooden handle  
 Martelette à briques avec manche en bois

COD. ART.	Gr.	L mm	BOX	COD. EAN - 13
MU 3840 LE	400	370	6	80 3264633 295 7
MU 3860 LE	600	370	6	80 3264633 319 0
Mercato / Markets / Marchés				



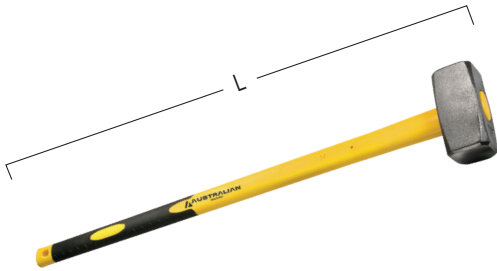

**Mazza a coppia con manico anima in fibra di vetro (impugnatura in gomma)**

Sledgehammer with glass fibre core handle (rubber haft)  
Masse couple avec manche trimatière

COD. ART.	Gr.	L mm	BOX	COD. EAN - 13
MA 3091 G	3000	910	4	80 3264633 105 9
MA 3100 G	3000	1000	4	80 3264633 255 1
MA 4091 G	4000	910	4	80 3264633 107 3
MA 4100 G	4000	1000	4	80 3264633 108 0
MA 5091 G	5000	910	4	80 3264633 109 7
MA 5100 G	5000	1000	4	80 3264633 110 3
MA 6091 G	6000	910	4	80 3264633 382 4
MA 6100 G	6000	1000	4	80 3264633 383 1
MA 8091 G	8000	910	3	80 3264633 239 1
MA 8100 G	8000	1000	3	80 3264633 384 8
MA 10091 G	10000	910	2	80 3264633 240 7
MA 10100 G	10000	1000	2	80 3264633 385 5

Mercato / Markets / Marchés



**Mazza a coppia con manico in legno Mix**

Sledgehammer with wooden handle Mix  
Masse couple avec manche en bois Mix

COD. ART.	Gr.	L mm	BOX	COD. EAN - 13
MA 3091 L/MIX	3000	910	4	80 3264633 247 6
MA 4091 L/MIX	4000	910	4	80 3264633 248 3
MA 5091 L/MIX	5000	910	4	80 3264633 249 0
MA 6091 L/MIX	6000	910	4	80 3264633 392 3
MA 8091 L/MIX	8000	910	3	80 3264633 393 0
MA 10091 L/MIX	10000	910	2	80 3264633 394 7

Mercato / Markets / Marchés



**Mazza a coppia con manico in frassino verniciato**

Sledgehammer with painted ash wood handle  
Masse couple avec manche en bois de frene verni

COD. ART.	Gr.	L mm	BOX	COD. EAN - 13
MA 3091 LFV	3000	910	4	80 5773372 058 5
MA 4091 LFV	4000	910	4	80 5773372 059 2
MA 5091 LFV	5000	910	4	80 3264633 647 4

Mercato / Markets / Marchés



**Mazza a coppia con manico in legno**

Sledgehammer with wooden handle  
Masse couple avec manche en bois

COD. ART.	Gr.	L mm	BOX	COD. EAN - 13
MA 3091 LE	3000	910	4	80 3264633 395 4
MA 4091 LE	4000	910	4	80 3264633 396 1
MA 5091 LE	5000	910	4	80 3264633 397 8
MA 6091 LE	6000	910	4	80 3264633 398 5
MA 8091 LE	8000	910	3	80 3264633 399 2
MA 10091 LE	10000	910	2	80 3264633 400 5

Mercato / Markets / Marchés

MARTELLERIA 4

MAZZE e PICCONI 20

SCALPELLI e LEVERINI 24

ARTICOLI PER PIETRA 26

SECCHI, CAZZUOLE, SPATOLE e VARIE 27

BADILI, PALE, RASCHIETTI e RASCHIAFANGO 39

ACCETTE, PICOZZINI, RONCOLE e MACETE 52

ASCE, MAZZESCURI e CUNEI 55

RASTRELLI, SARCHIATORI e AERATORI 61

SCOPE FOGLIE 69

RACCOLTA FRUTTA e TRATTAMENTO 78

NOVITÀ 84

FORCHE e VANGHE 90

ZAPPE, ZAPPINI, ATTREZZINI e FORBICI 94

MANICI FIBRA 101

MANICI MIX e LEGNO 115

ASTE TELESCOPICHE 123

ESPOSITORI 124

GUANTI 126

SOLLEVAMENTO e ANCORAGGIO 140

- 4 MARTELLERIA
- 20 MAZZE e PICCONI
- 24 SCALPELLI e LEVERINI
- 26 ARTICOLI PER PIETRA
- 27 SECCHI, CAZZUOLE, SPATOLE e VARIE
- 39 BADILI, PALE, RASCHIETTI e RASCHIAFANGO
- 52 ACCETTE, PICOZZINI, RONCOLE e MACETE
- 55 ASCE, MAZZESCURI e CUNEI
- 61 RASTRELLI, SARCHIATORI e AERATORI
- 69 SCOPE FOGLIE
- 78 RACCOLTA FRUTTA e TRATTAMENTO
- 84 NOVITÀ
- 90 FORCHE e VANGHE
- 94 ZAPPE, ZAPPINI, ATTREZZINI e FORBICI
- 101 MANICI FIBRA
- 115 MANICI MIX e LEGNO
- 123 ASTE TELESCOPICHE
- 124 ESPOSITORI
- 126 GUANTI
- 140 SOLLEVAMENTO e ANCORAGGIO



**Mazza a gemma con manico anima in fibra di vetro (impugnatura in gomma)**

Stone sledgehammer with glass fibre core handle (rubber haft)  
Masse à tranche avec manche trimatière

COD. ART.	Gr.	L mm	BOX	COD. EAN - 13
MGA 3091 G	3000	910	4	80 5773372 241 1
MGA 4091 G	4000	910	4	80 3264633 256 8
MGA 5091 G	5000	910	4	80 5773372 304 3
MGA 6091 G	6000	910	4	80 3264633 339 8

Mercato / Markets / Marchés



**Mazza a gemma con manico in legno Mix**

Stone sledgehammer with wooden handle Mix  
Masse à tranche avec manche en bois Mix

COD. ART.	Gr.	L mm	BOX	COD. EAN - 13
MGA 3091 L/MIX	3000	910	4	80 5773372 305 0
MGA 4091 L/MIX	4000	910	4	80 3264633 405 0
MGA 5091 L/MIX	5000	910	4	80 5773372 306 7
MGA 6091 L/MIX	6000	910	4	80 3264633 406 7

Mercato / Markets / Marchés



**Mazza a gemma con manico in frassino verniciato**

Stone sledgehammer with painted ash wood handle  
Masse à tranche avec manche en bois de frêne verni

COD. ART.	Gr.	L mm	BOX	COD. EAN - 13
MGA 3091 LFV	3000	910	4	80 5773372 307 4
MGA 4091 LFV	4000	910	4	80 5773372 063 9
MGA 5091 LFV	5000	910	4	80 5773372 308 1
MGA 6091 LFV	6000	910	4	80 5773372 064 6

Mercato / Markets / Marchés



**Mazza a gemma con manico in legno**

Stone sledgehammer with wood handle  
Masse à tranche avec manche en bois



COD. ART.	Gr.	L mm	BOX	COD. EAN - 13
MGA 3091 LE	3000	910	4	80 5773372 309 8
MGA 4091 LE	4000	910	4	80 3264633 344 2
MGA 5091 LE	5000	910	4	80 5773372 310 4
MGA 6091 LE	6000	910	4	80 3264633 345 9

Mercato / Markets / Marchés



**Mazza tedesca con manico anima in fibra di vetro (impugnatura in gomma)**



German sledgehammer with glass fibre core handle (rubber haft)  
Masse allemande avec manche trimatière

COD. ART.	Gr.	L mm	BOX	COD. EAN - 13
MTA 3091 G	3000	910	4	80 3264633 409 8
MTA 4091 G	4000	910	4	80 3264633 410 4
MTA 5091 G	5000	910	4	80 3264633 411 1
Mercato / Markets / Marchés				EU   



**Mazza tedesca con manico in legno Mix**



German sledgehammer with wooden handle Mix  
Masse allemande avec manche en bois Mix

COD. ART.	Gr.	L mm	BOX	COD. EAN - 13
MTA 3091 L/MIX	3000	910	4	80 3264633 415 9
MTA 4091 L/MIX	4000	910	4	80 3264633 416 6
MTA 5091 L/MIX	5000	910	4	80 3264633 417 3
Mercato / Markets / Marchés				EU   



**Mazza tedesca con manico in frassino verniciato**



German sledgehammer with painted ash wood handle  
Masse allemande avec manche en bois de frene verni

COD. ART.	Gr.	L mm	BOX	COD. EAN - 13
MTA 3091 LFV	3000	910	4	80 5773372 060 8
MTA 4091 LFV	4000	910	4	80 5773372 061 5
MTA 5091 LFV	5000	910	4	80 5773372 062 2
Mercato / Markets / Marchés				EU   



**Mazza tedesca con manico in legno**

German sledgehammer with wooden handle  
Masse allemande avec manche en bois

COD. ART.	Gr.	L mm	BOX	COD. EAN - 13
MTA 3091 L	3000	910	4	80 3264633 418 0
MTA 4091 L	4000	910	4	80 3264633 419 7
MTA 5091 L	5000	910	4	80 3264633 420 3
Mercato / Markets / Marchés				EU   

MARTELLERIA 4

MAZZE e PICCONI 20

SCALPELLI e LEVERINI 24

ARTICOLI PER PIETRA 26

SECCHI, CAZZUOLE, SPATOLE e VARIE 27

BADILI, PALE, RASCHIETTI e RASCHIAFANGO 39

ACCETTE, PICOZZINI, RONCOLE e MACETE 52

ASCE, MAZZESCURI e CUNEI 55

RASTRELLI, SARCHIATORI e AERATORI 61

SCOPE FOGLIE 69

RACCOLTA FRUTTA e TRATTAMENTO 78

NOVITÀ 84

FORCHE e VANGHE 90

ZAPPE, ZAPPINI, ATTREZZINI e FORBICI 94

MANICI FIBRA 101

MANICI MIX e LEGNO 115

ASTE TELESCOPICHE 123

ESPOSITORI 124

GUANTI 126

SOLLEVAMENTO e ANCORAGGIO 140

4 MARTELLERIA

20 **MAZZE e PICCONI**

24 SCALPELLI e LEVERINI

26 ARTICOLI PER PIETRA

27 SECCHI, CAZZUOLE, SPATOLE e VARIE

39 BADILI, PALE, RASCHIETTI e RASCHIAFANGO

52 ACCETTE, PICOZZINI, RONCOLE e MACETE

55 ASCE, MAZZESCURI e CUNEI

61 RASTRELLI, SARCHIATORI e AERATORI

69 SCOPE FOGLIE

78 RACCOLTA FRUTTA e TRATTAMENTO

84 NOVITÀ

90 FORCHE e VANGHE

94 ZAPPE, ZAPPINI, ATTREZZINI e FORBICI

101 MANICI FIBRA

115 MANICI MIX e LEGNO

123 ASTE TELESCOPICHE

124 ESPOSITORI

126 GUANTI

140 SOLLEVAMENTO e ANCORAGGIO

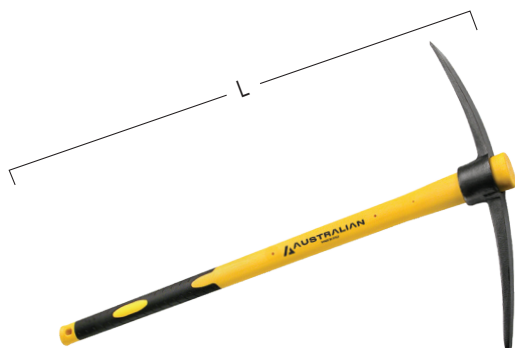

**Piccone italiano occhio ovale manico anima fibra di vetro (impugnatura in gomma)**

Oval eye italian pickaxe with glass fibre core handle (rubber haft)  
Pioche italienne douille ovale avec manche trimatière

COD. ART.	Gr.	L mm	BOX	COD. EAN - 13
PA 91 G	1500	910	8	80 3264633 121 9
PA 100 G	1500	1000	8	80 3264633 122 6
Mercato / Markets / Marchés				



**Piccone italiano occhio ovale con manico in legno Mix**

Oval eye italian pickaxe with wooden handle Mix  
Pioche italienne douille ovale avec manche en bois Mix

COD. ART.	Gr.	L mm	BOX	COD. EAN - 13
PA 95 L/MIX	1500	950	8	80 3264633 250 6
Mercato / Markets / Marchés				



**Piccone italiano occhio ovale manico frassino verniciato**

Oval eye italian pickaxe with painted ash wood handle  
Pioche italienne douille ovale avec manche en bois de fene verni

COD. ART.	Gr.	L mm	BOX	COD. EAN - 13
PA 95 LFV	1500	950	8	80 5773372 065 3
Mercato / Markets / Marchés				



**Piccone italiano occhio ovale con manico in legno**

Oval eye italian pickaxe with wooden handle  
Pioche italienne douille ovale avec manche en bois

COD. ART.	Gr.	L mm	BOX	COD. EAN - 13
PA 95 LE	1500	950	8	80 3264633 267 4
Mercato / Markets / Marchés				

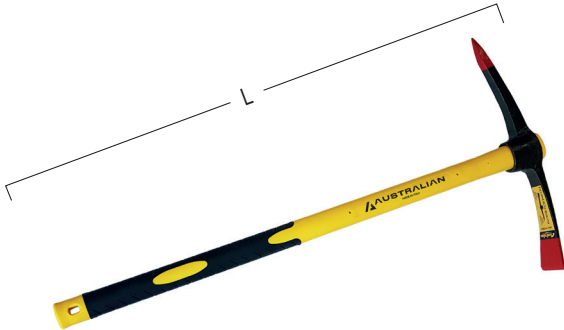

NEW

**Piccone italiano occhio ovale TOP manico anima fibra di vetro (impugnatura in gomma)**

Oval eye TOP italian pickaxe with glass fibre core handle (rubber haft)  
Pioche italienne douille ovale avec manche trimatière

COD. ART.	Gr.	L mm	BOX	COD. EAN - 13
PA 91 G TOP	1500	910	8	80 5773372 300 5
PA 100 G TOP	1500	1000	8	80 5773372 311 1

Mercato / Markets / Marchés

NEW

**Piccone italiano occhio ovale TOP manico frassino verniciato**

Oval eye italian pickaxe with wooden handle Mix  
Pioche italienne douille ovale avec manche en bois Mix

COD. ART.	Gr.	L mm	BOX	COD. EAN - 13
PA 95 LFV TOP	1500	950	8	80 5773372 301 2

Mercato / Markets / Marchés

**PICCONE ALTA QUALITÀ**



**RESISTENZA A DEFORMAZIONE 500 KG**

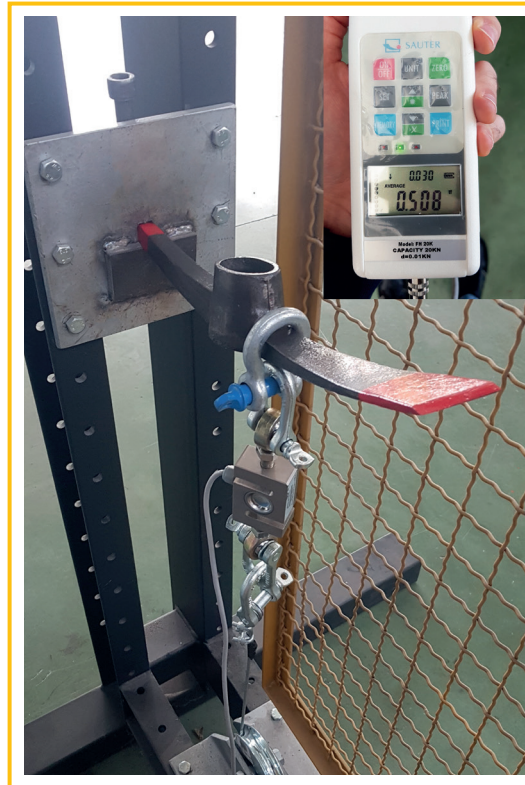

MARTELLERIA	4
<b>MAZZE e PICCONI</b>	<b>20</b>
SCALPELLI e LEVERINI	24
ARTICOLI PER PIETRA	26
SECCHI, CAZZUOLE, SPATOLE e VARIE	27
BADILI, PALE, RASCHIETTI e RASCHIAFANGO	39
ACCETTE, PICOZZINI, RONCOLE e MACETE	52
ASCE, MAZZESCURI e CUNEI	55
RASTRELLI, SARCHIATORI e AERATORI	61
SCOPE FOGLIE	69
RACCOLTA FRUTTA e TRATTAMENTO	78
NOVITÀ	84
FORCHE e VANGHE	90
ZAPPE, ZAPPINI, ATTREZZINI e FORBICI	94
MANICI FIBRA	101
MANICI MIX e LEGNO	115
ASTE TELESCOPICHE	123
ESPOSITORI	124
GUANTI	126
SOLLEVAMENTO e ANCORAGGIO	140

- 4 MARTELLERIA
- 20 MAZZE e PICCONI
- 24 SCALPELLI e LEVERINI
- 26 ARTICOLI PER PIETRA
- 27 SECCHI, CAZZUOLE, SPATOLE e VARIE
- 39 BADILI, PALE, RASCHIETTI e RASCHIAFANGO
- 52 ACCETTE, PICOZZINI, RONCOLE e MACETE
- 55 ASCE, MAZZESCURI e CUNEI
- 61 RASTRELLI, SARCHIATORI e AERATORI
- 69 SCOPE FOGLIE
- 78 RACCOLTA FRUTTA e TRATTAMENTO
- 84 NOVITÀ
- 90 FORCHE e VANGHE
- 94 ZAPPE, ZAPPINI, ATTREZZINI e FORBICI
- 101 MANICI FIBRA
- 115 MANICI MIX e LEGNO
- 123 ASTE TELESCOPICHE
- 124 ESPOSITORI
- 126 GUANTI
- 140 SOLLEVAMENTO e ANCORAGGIO



**Piccone francese con occhio rotondo e manico anima in fibra di vetro (impugnatura in gomma)**

Round eye french pickaxe with glass fibre core handle (rubber haft)  
Pioche française douille ronde avec manche trimatière

COD. ART.	Gr.	L mm	BOX	COD. EAN - 13
PT 9120 G	2000	910	8	80 3264633 162 2
PT 9125 G	2500	910	8	80 3264633 163 9

Mercato / Markets / Marchés



**Piccone francese con occhio rotondo e manico in legno Mix**

Round eye french pickaxe with wooden handle Mix  
Pioche française douille ronde avec manche en bois Mix

COD. ART.	Gr.	L mm	BOX	COD. EAN - 13
PT 9120 L/MIX	2000	910	8	80 3264633 371 8
PT 9125 L/MIX	2500	910	8	80 3264633 372 5

Mercato / Markets / Marchés



**Piccone francese con occhio rotondo e manico in legno**

Round eye french pickaxe with wooden handle  
Pioche française douille ronde avec manche en bois

COD. ART.	Gr.	L mm	BOX	COD. EAN - 13
PT 9120 L	2000	910	8	80 3264633 373 2
PT 9125 L	2500	910	8	80 3264633 374 9

Mercato / Markets / Marchés



**Piccone svizzero con manico anima in fibra di vetro (impugnatura in gomma)**

Helvetic pickaxe with glass fibre core handle (rubber haft)  
Pioche suisse avec manche trimatière

COD. ART.	Gr.	L mm	BOX	COD. EAN - 13
POS1591G	1500	910	8	80 5773372 717 1
POS2091G	2000	910	8	80 5773372 126 1
POS2591G	2500	910	8	80 5773372 127 8
POS91G	2800	910	8	80 3264633 376 3
POS3091G	3000	910	8	80 5773372 128 5

Mercato / Markets / Marchés



**Piccone svizzero con manico in legno Mix**

Helvetic pickaxe with wooden handle Mix  
Pioche suisse avec manche en bois Mix

COD. ART.	Gr.	L mm	BOX	COD. EAN - 13
POS2591L/MIX	2500	910	8	80 5773372 129 2
POS91L/MIX	2800	910	8	80 3264633 378 7
POS3091L/MIX	3000	910	8	80 3264633 130 8

Mercato / Markets / Marchés



**Piccone svizzero con manico in legno**

Helvetic pickaxe with wooden handle  
Pioche suisse avec manche en bois

COD. ART.	Gr.	L mm	BOX	COD. EAN - 13
POS1591L	1500	910	8	80 5773372 718 8
POS2091L	2000	910	8	80 5773372 087 5
POS2591L	2500	910	8	80 5773372 088 2
POS91L	2800	910	8	80 3264633 379 4
POS3091L	3000	910	8	80 5773372 089 9

Mercato / Markets / Marchés



**Mazza a coppia senza manico**

Sledgehammer with out handle  
Masse couple sans manche

COD. ART.	Gr.	BOX	COD. EAN - 13
MC 30	3000	4	80 3264633 316 9
MC 40	4000	4	80 3264633 317 6
MC 50	5000	4	80 3264633 318 3
MC 60	6000	4	80 3264633 401 2
MC 80	8000	3	80 3264633 402 9
MC 100	10000	2	80 3264633 403 6

Mercato / Markets / Marchés



**Mazza tedesca senza manico**

German sledgehammer without handle  
Masse allemande sans manche

COD. ART.	Gr.	BOX	COD. EAN - 13
MT 30	3000	4	80 3264633 421 0
MT 40	4000	4	80 3264633 422 7
MT 50	5000	4	80 3264633 423 4

Mercato / Markets / Marchés



**Mazza a gemma senza manico**

Stone sledgehammer without handle  
Masse à tranche sans manche

COD. ART.	Gr.	BOX	COD. EAN - 13
MG 30	3000	4	80 5773372 210 7
MG 40	4000	4	80 3264633 407 4
MG 50	5000	4	80 5773372 211 4
MG 60	6000	4	80 3264633 408 1

Mercato / Markets / Marchés



NEW

**Piccone italiano occhio ovale TOP senza manico**

Oval eye TOP italian pickaxe without handle  
Pioche italienne TOP douille ovale sans manche

COD. ART.	Gr.	BOX	COD. EAN - 13
P 1500 I TOP	1500	6	80 5773372 299 2

Mercato / Markets / Marchés



**Piccone italiano occhio ovale senza manico**

Oval eye italian pickaxe without handle  
Pioche italienne douille ovale sans manche

COD. ART.	Gr.	BOX	COD. EAN - 13
P 1500 I	1500	6	80 3264633 368 8
P 1500 I E	1500	6	80 3264633 315 2

Mercato / Markets / Marchés



**Piccone francese con occhio rotondo senza manico**

Round eye french pickaxe without handle  
Pioche française douille ronde sans manche

COD. ART.	Gr.	BOX	COD. EAN - 13
PT 2000	2000	12	80 3264633 970 3
PT 2500	2500	12	80 3264633 375 6

Mercato / Markets / Marchés



**Piccone svizzero senza manico**

Helvetic pickaxe without handle  
Pioche suisse sans manche

COD. ART.	Gr.	BOX	COD. EAN - 13
PS 1500	1500	12	80 5773372 077 6
PS 2000	2000	12	80 5773372 090 5
PS 2500	2500	12	80 5773372 091 2
PS 2800	2800	12	80 3264633 380 0
PS 3000	3000	12	80 5773372 092 9

Mercato / Markets / Marchés

MARTELLERIA 4

MAZZE e PICCONI 20

SCALPELLI e LEVERINI 24

ARTICOLI PER PIETRA 26

SECCHI, CAZZUOLE, SPATOLE e VARIE 27

BADILI, PALE, RASCHIETTI e RASCHIAFANGO 39

ACCETTE, PICOZZINI, RONCOLE e MACETE 52

ASCE, MAZZESCURI e CUNEI 55

RASTRELLI, SARCHIATORI e AERATORI 61

SCOPE FOGLIE 69

RACCOLTA FRUTTA e TRATTAMENTO 78

NOVITÀ 84

FORCHE e VANGHE 90

ZAPPE, ZAPPINI, ATTREZZINI e FORBICI 94

MANICI FIBRA 101

MANICI MIX e LEGNO 115

ASTE TELESCOPICHE 123

ESPOSITORI 124

GUANTI 126

SOLLEVAMENTO e ANCORAGGIO 140

- 4 MARTELLERIA
- 20 MAZZE e PICCONI
- 24 **SCALPELLI e LEVERINI**
- 26 ARTICOLI PER PIETRA
- 27 SECCHI, CAZZUOLE, SPATOLE e VARIE
- 39 BADILI, PALE, RASCHIETTI e RASCHIAFANGO
- 52 ACCETTE, PICOZZINI, RONCOLE e MACETE
- 55 ASCE, MAZZESCURI e CUNEI
- 61 RASTRELLI, SARCHIATORI e AERATORI
- 69 SCOPE FOGLIE
- 78 RACCOLTA FRUTTA e TRATTAMENTO
- 84 NOVITÀ
- 90 FORCHE e VANGHE
- 94 ZAPPE, ZAPPINI, ATTREZZINI e FORBICI
- 101 MANICI FIBRA
- 115 MANICI MIX e LEGNO
- 123 ASTE TELESCOPICHE
- 124 ESPOSITORI
- 126 GUANTI
- 140 SOLLEVAMENTO e ANCORAGGIO

### Leverino in acciaio stampato temprato

Forged tempered steel lever  
Levier en acier trempé

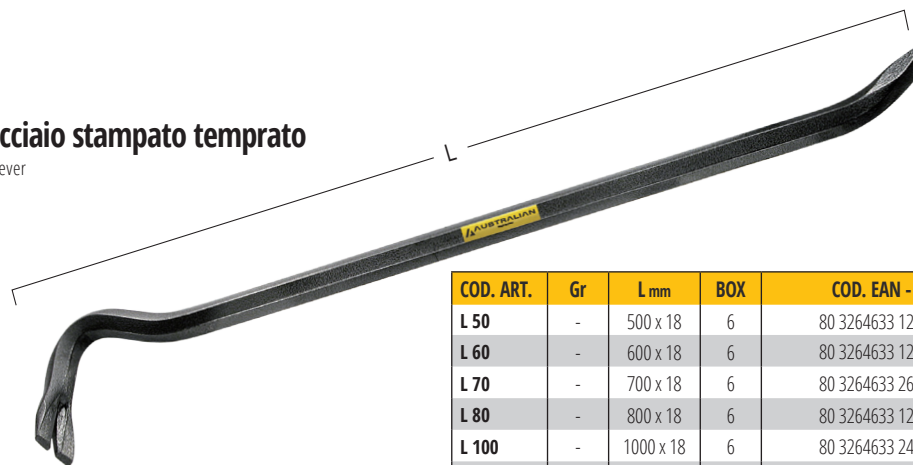

COD. ART.	Gr	L mm	BOX	COD. EAN - 13
L 50	-	500 x 18	6	80 3264633 125 7
L 60	-	600 x 18	6	80 3264633 126 4
L 70	-	700 x 18	6	80 3264633 268 1
L 80	-	800 x 18	6	80 3264633 127 1
L 100	-	1000 x 18	6	80 3264633 243 8
L 120	-	1200 x 18	6	80 5773372 312 8
L 150	-	1500 x 18	6	80 5773372 313 5

Mercato / Markets / Marchés

**NEW**

### Chiodo fermarighe

Gamba in acciaio riaffilabile al cromo/vanadio ottagonale mm. 10 in acciaio al carbonio  
Resharpenable steel with chrome / vanadium octagonal mm. 10 in carbon steel  
Pied en acier réaffûtable avec chrome / vanadium octogonal mm. 10 en acier au carbone



COD. ART.	Gr	L mm	BOX	COD. EAN - 13
F25	-	250 x 130	6	80 5773372 314 2

Mercato / Markets / Marchés

### Scalpellista a taglio testa temperata

Cutting-shaped electrician's chisel with hardened head  
Ciseau d'électricien à coupe avec tête trempée



COD. ART.	A mm	L mm	BOX	COD. EAN - 13
SETL 20	16	200	6	80 3264633 308 4
SETL 25	16	250	6	80 3264633 309 1
SETL 30	16	300	6	80 5773372 125 4

Mercato / Markets / Marchés

**NEW**

### Scalpellista a punta testa temperata

Point-shaped electrician's chisel with hardened head  
Ciseau d'électricien pointu avec tête trempée



COD. ART.	A mm	L mm	BOX	COD. EAN - 13
SEPL 20	-	200	6	80 5773372 334 0
SEPL 25	-	250	6	80 5773372 335 7
SEPL 30	-	300	6	80 5773372 336 4

Mercato / Markets / Marchés



MARTELLERIA	4
MAZZE e PICCONI	20
<b>SCALPELLI e LEVERINI</b>	<b>24</b>
ARTICOLI PER PIETRA	26
SECCHI, CAZZUOLE, SPATOLE e VARIE	27
BADILI, PALE, RASCHIETTI e RASCHIAFANGO	39
ACCETTE, PICOZZINI, RONCOLE e MACETE	52
ASCE, MAZZESCURI e CUNEI	55
RASTRELLI, SARCHIATORI e AERATORI	61
SCOPE FOGLIE	69
RACCOLTA FRUTTA e TRATTAMENTO	78
NOVITÀ	84
FORCHE e VANGHE	90
ZAPPE, ZAPPINI, ATTREZZINI e FORBICI	94
MANICI FIBRA	101
MANICI MIX e LEGNO	115
ASTE TELESCOPICHE	123
ESPOSITORI	124
GUANTI	126
SOLLEVAMENTO e ANCORAGGIO	140

### Scalpello a taglio in Cr-V riaffilabile testa temperata (impugnatura in gomma)

Re-sharpable Cr-V cutting-shaped chisel with hardened head rubber haft  
Ciseau à coupe au Cr-V réaffûtable avec tête trempée poignée gomme

COD. ART.	A mm	L mm	BOX	COD. EAN - 13
ST 27 TTG	22	270	6	80 3264633 909 3
ST 30 TTG	22	300	6	80 3264633 910 9
ST 35 TTG	22	350	6	80 3264633 302 2
ST 40 TTG	22	400	6	80 3264633 329 9

Mercato / Markets / Marchés

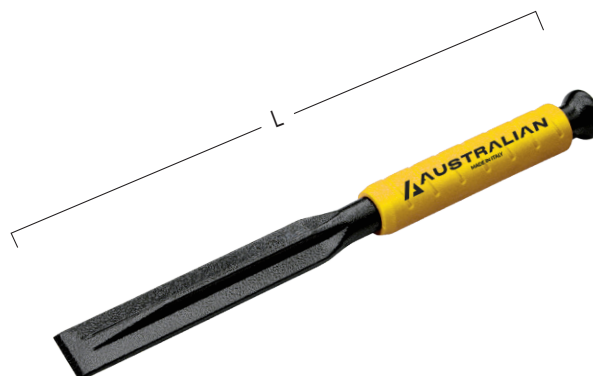

### Scalpello a punta in Cr-V riaffilabile testa temperata (impugnatura in gomma)

Re-sharpable Cr-V pointed chisel with hardened head rubber haft  
Ciseau à pointe au Cr-V réaffûtable avec tête trempée poignée gomme

COD. ART.	A mm	L mm	BOX	COD. EAN - 13
SP 27 TTG	-	270	6	80 3264633 303 9
SP 30 TTG	-	300	6	80 3264633 304 6
SP 35 TTG	-	350	6	80 3264633 305 3
SP 40 TTG	-	400	6	80 3264633 330 5

Mercato / Markets / Marchés



### Scalpello largo in riaffilabile testa temperata (impugnatura in gomma)

Re-sharpable wide chisel with hardened head rubber haft  
Ciseau large au réaffûtable avec tête trempée poignée gomme

COD. ART.	A mm	L mm	BOX	COD. EAN - 13
SL 50 TTG	50	250	6	80 3264633 306 0
SL 70 TTG	70	250	6	80 3264633 307 7

Mercato / Markets / Marchés



- 4 MARTELLERIA
- 20 MAZZE e PICCONI
- 24 SCALPELLI e LEVERINI
- 26 **ARTICOLI PER PIETRA**
- 27 SECCHI, CAZZUOLE, SPATOLE e VARIE
- 39 BADILI, PALE, RASCHIETTI e RASCHIAFANGO
- 52 ACCETTE, PICOZZINI, RONCOLE e MACETE
- 55 ASCE, MAZZESCURI e CUNEI
- 61 RASTRELLI, SARCHIATORI e AERATORI
- 69 SCOPE FOGLIE
- 78 RACCOLTA FRUTTA e TRATTAMENTO
- 84 NOVITÀ
- 90 FORCHE e VANGHE
- 94 ZAPPE, ZAPPINI, ATTREZZINI e FORBICI
- 101 MANICI FIBRA
- 115 MANICI MIX e LEGNO
- 123 ASTE TELESCOPICHE
- 124 ESPOSITORI
- 126 GUANTI
- 140 SOLLEVAMENTO e ANCORAGGIO

### Scalpello a taglio in Cr-V riaffilabile testa temperata

Re-sharpable Cr-V cutting-shaped chisel with hardened head  
Ciseau à coupe au Cr-V réaffûtable avec tête trempée

COD. ART.	A mm	L mm	BOX	COD. EAN - 13
SP 27 /INS	22	270	6	80 5773372 724 9
SP 30 /INS	22	300	6	80 5773372 725 6
SP 35 /INS	22	350	6	80 5773372 726 3
SP 40 /INS	22	400	6	80 5773372 727 0

Mercato / Markets / Marchés



### Scalpello a punta in Cr-V riaffilabile testa temperata

Re-sharpable Cr-V pointed chisel with hardened head  
Ciseau à pointe au Cr-V réaffûtable avec tête trempée

COD. ART.	A mm	L mm	BOX	COD. EAN - 13
ST 27 /INS		270	6	80 5773372 728 7
ST 30 /INS		300	6	80 5773372 729 7
ST 35 /INS		350	6	80 5773372 730 0
ST 40 /INS		400	6	80 5773372 731 7

Mercato / Markets / Marchés



### Scalpello largo riaffilabile testa temperata

Re-sharpable wide chisel with hardened head  
Ciseau large réaffûtable avec tête trempée

COD. ART.	A mm	L mm	BOX	COD. EAN - 13
SL 50 /INS	50	250	6	80 5773372 732 4
ST 70 /INS	70	250	6	80 5773372 733 1

Mercato / Markets / Marchés



### Mazzetta antisfilamento al widia con manico in fibra di vetro (impugnatura in gomma)

Anti-unthreading widia blocksmith hammer with fiberglass core handle (rubber haft)  
Massette antieffilement au widia avec manche trimatière

COD. ART.	Gr	H mm	BOX	COD. EAN - 13
MM 1000 G/SVW	1000	270	1	80 3264633 310 7

Mercato / Markets / Marchés



**AUSTRALIAN**

# INSACCATUTTO

**UN LAVORO  
UN PRODOTTO  
LA SOLUZIONE**



scopri di più

**PRIMA**



**DOPO**



**INSACCA RAPIDAMENTE: calcinacci, ghiaia, sabbia, foglie, cereali**



## Insaccatutto - imbuto per insaccare macerie, sabbia e foglie

Insaccatutto - funnel bucket to sack rubble, sand and leaves  
Insaccatutto - entonnoir pour ensacher gravats, sable et feuilles

COD. ART.	A mm	B mm	BOX	COD. EAN - 13
IT 71	230	710	8	80 5773372 595 5
Mercato / Markets / Marchés				



MARTELLERIA	4
MAZZE e PICCONI	20
SCALPELLI e LEVERINI	24
ARTICOLI PER PIETRA	26
<b>SECCHI, CAZZUOLE, SPATOLE e VARIE</b>	<b>27</b>
BADILI, PALE, RASCHIETTI e RASCHIAFANGO	39
ACCETTE, PICOZZINI, RONCOLE e MACETE	52
ASCE, MAZZESCURI e CUNEI	55
RASTRELLI, SARCHIATORI e AERATORI	61
SCOPE FOGLIE	69
RACCOLTA FRUTTA e TRATTAMENTO	78
NOVITÀ	84
FORCHE e VANGHE	90
ZAPPE, ZAPPINI, ATTREZZINI e FORBICI	94
MANICI FIBRA	101
MANICI MIX e LEGNO	115
ASTE TELESCOPICHE	123
ESPOSITORI	124
GUANTI	126
SOLLEVAMENTO e ANCORAGGIO	140

- 4 MARTELLERIA
- 20 MAZZE e PICCONI
- 24 SCALPELLI e LEVERINI
- 26 ARTICOLI PER PIETRA
- 27 SECCHI, CAZZUOLE, SPATOLE e VARIE**
- 39 BADILI, PALE, RASCHIAI e RASCHIAFANGO
- 52 ACCETTE, PICOZZINI, RONCOLE e MACETE
- 55 ASCE, MAZZESCURI e CUNEI
- 61 RASTRELLI, SARCHIATORI e AERATORI
- 69 SCOPE FOGLIE
- 78 RACCOLTA FRUTTA e TRATTAMENTO
- 84 NOVITÀ
- 90 FORCHE e VANGHE
- 94 ZAPPE, ZAPPINI, ATTREZZINI e FORBICI
- 101 MANICI FIBRA
- 115 MANICI MIX e LEGNO
- 123 ASTE TELESCOPICHE
- 124 ESPOSITORI
- 126 GUANTI
- 140 SOLLEVAMENTO e ANCORAGGIO



**SR 36 . Secchio rosso in materiale plastico  
con manico zincato Ø 7 mm**

Red plastic bucket with galvanized handle Ø 7 mm  
Seau rouge en matière plastique avec manche galvanisé Ø 7 mm

COD. ART.	Manico	Colore	Dim.	Gr.	Conf.	Pallet	COD. EAN - 13
SR_36	Ø 6 mm	Rosso	360 mm	770	12	864 pz	80 3264633 320 6
Mercato / Markets / Marchés							

**DOPPIA MANIGLIA**

Permette il ribaltamento istintivo per destrorsi e mancini

**Two handles:** they allow the instinctive overturning for both right-handed and left-handed people

**Deux poignées:** elles permettent le renversement instinctif pour les dextrorses et les gauchers



**GRADUATO**

Scala graduata all'interno che indica la quantità del contenuto espressa in litri

**Graduated:** graduated measure inside that indicates the quantity of the contents in litres

**Gradué:** échelle graduée dedans qui indique la quantité du contenu en litres

**GANCI ANTINFORTUNISTICI**

Ganci protetti dal bordo  
**Accident prevention hooks:** hooks turned inside  
**Crochets contre es accidents:** crochets tournés au-dedans

MARTELLERIA 4

MAZZE e PICCONI 20

SCALPELLI e LEVERINI 24

ARTICOLI PER PIETRA 26

**SECCHI, CAZZUOLE, SPATOLE e VARIE 27**

BADILI, PALE, RASCHIETTI e RASCHIAFANGO 39

ACCETTE, PICOZZINI, RONCOLE e MACETE 52

ASCE, MAZZESCURI e CUNEI 55

RASTRELLI, SARCHIATORI e AERATORI 61

SCOPE FOGLIE 69

RACCOLTA FRUTTA e TRATTAMENTO 78

NOVITÀ 84

FORCHE e VANGHE 90

ZAPPE, ZAPPINI, ATTREZZINI e FORBICI 94

MANICI FIBRA 101

MANICI MIX e LEGNO 115

ASTE TELESCOPICHE 123

ESPOSITORI 124

GUANTI 126

SOLLEVAMENTO e ANCORAGGIO 140

## SSB 36 . Secchio bianco (o giallo a richiesta) in materiale plastico super resistente con manico antinfortunistico Ø 7 mm ergonomico

Super resistant yellow plastic bucket with accident prevention handle Ø 7 mm  
Seau jaune en matière plastique super résistant avec manche contre les accidents Ø 7 mm

COD. ART.	Manico	Colore	Dim.	Gr.	Conf.	Pallet	COD. EAN - 13
SSB_36	Ø 7 mm	Bianco	360 mm	800	12	756 pz	80 3264633 686 3
Mercato / Markets / Marchés							

### GARANTITO

Garantito 24 mesi contro la rottura per caduta da 1,5 mt di altezza ( è presente sul fondo la data del lotto di produzione in rilievo )

**Guaranteed:** it is guaranteed 24 months for breaking due to fall from 1,5 mt of height (on its bottom there is the date of the lot of production in relief)

**Garanti:** il est garanti 24 mois à rupture pour chute de 1,5 mt de hauteur ( sur le fond il y a la date du lot de production en relief )

### RESISTENTE AL CALORE

Non ha problemi di cristallizzazione anche nei luoghi e nei periodi più caldi ( temperatura di utilizzo fino a 50° C )

**Heat resistant:** it hasn't got problems of crystallization even in hottest places and periods ( temperature of use up to 50°C )

**Résistant au chaleur:** il n'a pas des problèmes de cristallisation même dans les lieux et les périodes les plus chauds ( température d'utilisation jusqu'à 50°C )

### RESISTENTE UV

Materiale plastico resistente ai raggi UV

**UV resistant:** plastic material resistant to UV rays

**Rayons UV:** matière plastique résistante aux rayons UV

### ANTIGELO

Materiale resistente al freddo (temperatura di utilizzo fino a -40° C )

**Antifreeze:** material resistant to the cold ( use up to -40°C )

**Antigel:** matière résistante au froid ( utilisation jusqu'à -40°C )

### IMPUGNATURA ERGONOMICA

Maniglia ergonomica di grosso diametro costampata sulla parte piana del manico in filo di acciaio (per evitare le tendiniti e le infiammazioni del tunnel carpale)

**Ergonomic handle:** big diameter ergonomic handle co-moulded on the level part of the steel wire handle (to avoid tendinitis and inflammation of the carpal tunnel)

**Manche ergonomique:** manche ergonomique de grand diamètre imprimé sur la partie plate du manche en fil d'acier (pour éviter tendinite et inflammation du tunnel carpien)

### MATERIALE ANTIURTO

Resiste all'urto provocato da una caduta libera da 1,5 mt di altezza anche quando è pieno di materiale

**Shock resistant material:** it resists to the impact due to a free fall from 1,5 mt of height even when it is full of material

**Matière antichoc:** il résiste au choc causé par une chute libre de 1,5 mt de hauteur même s'il est plein de matière



**DISPONIBILE  
ANCHE  
BIANCO**

### GANCI ANTINFORTUNISTICI

Ganci protetti dal bordo  
**Accident prevention hooks:**  
hooks turned inside

**Crochets contre es accidents:**  
crochets tournés au-dedans

### DOPPIA MANIGLIA

Permette il ribaltamento istintivo per destrorsi e mancini

**Two handles:** they allow the instinctive overturning for both right-handed and left-handed people

**Deux poignées:** elles permettent le renversement instinctif pour les dextrorsés et les gauchers

### GRADUATO

Scala graduata all'interno che indica la quantità del contenuto espressa in litri

**Graduated:** graduated measure inside that indicates the quantity of the contents in litres

**Gradué:** échelle graduée dedans qui indique la quantité du contenu en litres

## SSG 36. Secchio giallo in materiale plastico super resistente con manico antinfortunistico Ø 7 mm

Super resistant yellow plastic bucket with accident prevention handle Ø 7 mm  
Seau jaune en matière plastique super résistant avec manche contre les accidents Ø 7 mm

COD. ART.	Manico	Colore	Dim.	Gr.	Conf.	Pallet	COD. EAN - 13
SSG_36	Ø 7 mm	Giallo	360 mm	840	12	756 pz	80 3264633 284 1
Mercato / Markets / Marchés							

### GARANTITO

Garantito 24 mesi contro la rottura per caduta da 1,5 mt di altezza (è presente sul fondo la data del lotto di produzione in rilievo)

**Guaranteed:** it is guaranteed 24 months for breaking due to fall from 1,5 mt of height (on its bottom there is the date of the lot of production in relief)

**Garanti:** il est garanti 24 mois à rupture pour chute de 1,5 mt de hauteur (sur le fond il y a la date du lot de production en relief)

### RESISTENTE AL CALORE

Non ha problemi di cristallizzazione anche nei luoghi e nei periodi più caldi (temperatura di utilizzo fino a 50° C)

**Heat resistant:** it hasn't got problems of crystallization even in hottest places and periods (temperature of use up to 50°C)

**Résistant au chaleur:** il n'a pas des problèmes de cristallisation même dans les lieux et les périodes les plus chauds (température d'utilisation jusqu'à 50°C)

### RESISTENTE UV

Materiale plastico resistente ai raggi UV

**UV resistant:** plastic material resistant to UV rays

**Rayons UV:** matière plastique résistante aux rayons UV

### ANTIGELO

Materiale resistente al freddo

(temperatura di utilizzo fino a -40° C)

**Antifreeze:** material resistant to the cold (use up to -40°C)

**Antigel:** matière résistante au froid (utilisation jusqu'à -40°C)

### IMPUGNATURA ERGONOMICA

Maniglia ergonomica di grosso diametro costampata sulla parte piana del manico in filo di acciaio (per evitare le tendiniti e le infiammazioni del tunnel carpale)

**Ergonomic handle:** big diameter ergonomic handle moulded on the level part of the steel wire handle (to avoid tendinitis and inflammation of the carpal tunnel)

**Manche ergonomique:** manche ergonomique de grand diamètre imprimé sur la partie plate du manche en fil d'acier (pour éviter tendinite et inflammation du tunnel carpien)

### MATERIALE ANTIURTO

Resiste all'urto provocato da una caduta libera da 1,5 mt di altezza anche quando è pieno di materiale

**Shock resistant material:** it resists to the impact due to a free fall from 1,5 mt of height even when it is full of material

**Matière antichoc:** il résiste au choc causé par une chute libre de 1,5 mt de hauteur même s'il est plein de matière



### DOPPIA MANIGLIA

Permette il ribaltamento istintivo per destrorsi e mancini

**Two handles:** they allow the instinctive overturning for both right-handed and left-handed people

**Deux poignées:** elles permettent le renversement instinctif pour les dextrorsés et les gauchers

### GANCI ALL'INTERNO

Ganci rivolti all'interno

**Hooks inside:**

hooks turned inside

**Crochets a dedans:**

crochets tournés au-dedans

### GRADUATO

Scala graduata all'interno che indica la quantità del contenuto espressa in litri

**Graduated:** graduated measure inside that indicates the quantity of the contents in litres

**Gradué:** échelle graduée dedans qui indique la quantité du contenu en litres

MARTELLERIA 4

MAZZE e PICCONI 20

SCALPELLI e LEVERINI 24

ARTICOLI PER PIETRA 26

SECCHI, CAZZUOLE, SPATOLE e VARIE 27

BADILI, PALE, RASCHIETTI e RASCHIAFANGO 39

ACCETTE, PICOZZINI, RONCOLE e MACETE 52

ASCE, MAZZESCURI e CUNEI 55

RASTRELLI, SARCHIATORI e AERATORI 61

SCOPE FOGLIE 69

RACCOLTA FRUTTA e TRATTAMENTO 78

NOVITÀ 84

FORCHE e VANGHE 90

ZAPPE, ZAPPINI, ATTREZZINI e FORBICI 94

MANICI FIBRA 101

MANICI MIX e LEGNO 115

ASTE TELESCOPICHE 123

ESPOSITORI 124

GUANTI 126

SOLLEVAMENTO e ANCORAGGIO 140

**SAR 36. Secchio TOP in materiale plastico RIGIDO antiurto con manico in ferro Ø 8 mm**

TOP bucket in STIFF plastic material, shock resistant, with iron handle Ø 8 MM  
Seau TOP en matière plastique RIGIDE, antichoc, avec manche en fer Ø 8 MM

COD. ART.	Manico	Colore	Dim.	Gr.	Conf.	Pallet	COD. EAN - 13
SAR 36	Ø 8 MM	BLU	360 mm	800	12	756 pz	80 5773372 131 5
Mercato / Markets / Marchés							

**GARANTITO**

Garantito 24 mesi contro la rottura per caduta da 2,5 mt di altezza ( è presente sul fondo la data del lotto di produzione in rilievo )

**Guaranteed:** it is guaranteed 24 months for breaking due to fall from 2,5 mt of height (on its bottom there is the date of the lot of production in relief)

**Garanti:** il est garanti 24 mois à rupture pour chute de 2,5 mt de hauteur ( sur le fond il y a la date du lot de production en relief )

**RESISTENTE AL CALORE**

Non ha problemi di cristallizzazione anche nei luoghi e nei periodi più caldi ( temperatura di utilizzo fino a 60° C )

**Heat resistant:** it hasn't got problems of crystallization even in hottest places and periods ( temperature of use up to 60°C )

**Résistant au chaleur:** il n'a pas des problèmes de cristallisation même dans les lieux et les périodes les plus chauds ( température d'utilisation jusqu'à 60°C )

**RESISTENTE UV**

Materiale plastico resistente ai raggi UV

**UV resistant:** plastic material resistant to UV rays

**Rayons UV:** matière plastique résistante aux rayons UV

**ANTIGELO**

Materiale resistente al freddo (temperatura di utilizzo fino a -50° C )

**Antifreeze:** material resistant to the cold ( use up to -50°C )

**Antigel:** matière résistante au froid ( utilisation jusqu'à -50°C )

**MATERIALE ANTIURTO**

Resiste all'urto provocato da una caduta libera da 2,5 mt di altezza anche quando è pieno di materiale

**Shock resistant material:** it resists to the impact due to a free fall from 2,5 mt of height even when it is full of material

**Matière antichoc:** il résiste au choc causé par une chute libre de 2,5 mt de hauteur même s'il est plein de matière

**IMPUGNATURA IN FERRO**

Maniglia in ferro Ø 8 MM  
Iron handle Ø 8 MM  
Manche en fer Ø 8 MM

**GANCI ANTINFORTUNISTICI**

Ganci protetti dal bordo  
**Accident prevention hooks:** hooks turned inside  
**Crochets contre les accidents:** crochets tournés au-dedans

**DOPPIA MANIGLIA**

Permette il ribaltamento istintivo per destrorsi e mancini

**Two handles:** they allow the instinctive overturning for both right-handed and left-handed people

**Deux poignées:** elles permettent le renversement instinctif pour les dextrorsos et les gauchers

**GRADUATO**

Scala graduata all'interno che indica la quantità del contenuto espressa in litri

**Graduated:** graduated measure inside that indicates the quantity of the contents in litres

**Gradué:** échelle graduée dedans qui indique la quantité du contenu en litres

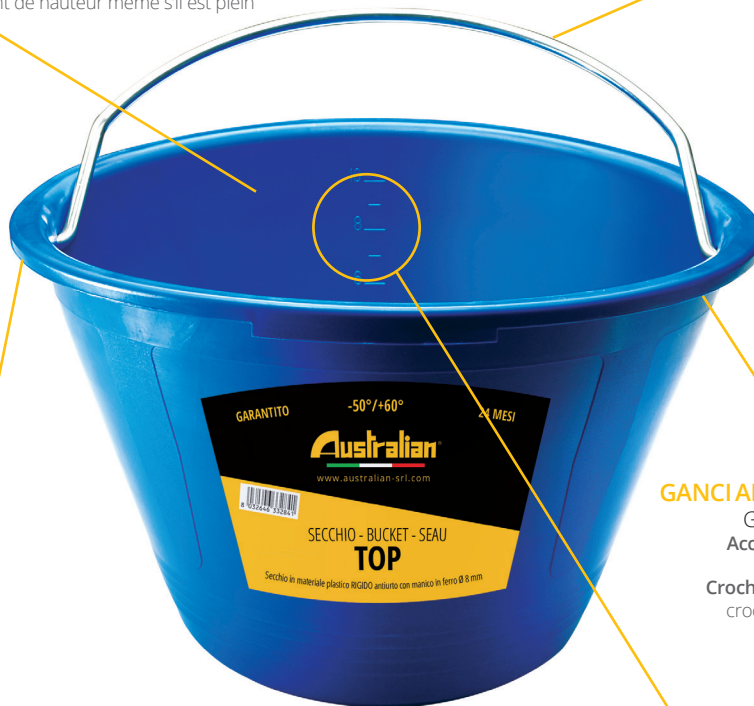

- 4 MARTELLERIA
- 20 MAZZE e PICCONI
- 24 SCALPELLI e LEVERINI
- 26 ARTICOLI PER PIETRA
- 27 **SECCHI, CAZZUOLE, SPATOLE e VARIE**
- 39 BADILI, PALE, RASCHIETTI e RASCHIAFANGO
- 52 ACCETTE, PICOZZINI, RONCOLE e MACETE
- 55 ASCE, MAZZESCURI e CUNEI
- 61 RASTRELLI, SARCHIATORI e AERATORI
- 69 SCOPE FOGLIE
- 78 RACCOLTA FRUTTA e TRATTAMENTO
- 84 NOVITÀ
- 90 FORCHE e VANGHE
- 94 ZAPPE, ZAPPINI, ATTREZZINI e FORBICI
- 101 MANICI FIBRA
- 115 MANICI MIX e LEGNO
- 123 ASTE TELESCOPICHE
- 124 ESPOSITORI
- 126 GUANTI
- 140 SOLLEVAMENTO e ANCORAGGIO



### Portamartello ad inserimento automatico

Automatic insertion hammer holder  
Porte-marteau à insertion automatique

COD. ART.	L mm	BOX	COD. EAN - 13
PM	-	12	80 3264633 311 4
Mercato / Markets / Marchés			EU

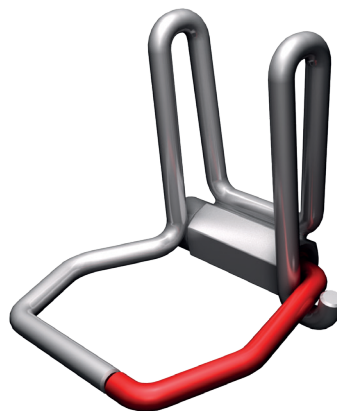

### Portamartello in acciaio zinco-cromato

Chrome-galvanized steel hammer holder  
Porte-marteau en acier chrome-galvanisé

COD. ART.	L mm	BOX	COD. EAN - 13
PMZ	-	12	80 5773372 076 9
Mercato / Markets / Marchés			EU



### Cassetta portatutto

Carrier box  
Boîte pour tous

COD. ART.	A	B	H	Gr.	BOX	PALLET	COD. EAN - 13
CU	40	30	20	1200	6	132 pz	80 3264633 503 3
Mercato / Markets / Marchés							IT



MARTELLERIA	4
MAZZE e PICCONI	20
SCALPELLI e LEVERINI	24
ARTICOLI PER PIETRA	26
<b>SECCHI, CAZZUOLE, SPATOLE e VARIE</b>	<b>27</b>
BADILI, PALE, RASCHIETTI e RASCHIAFANGO	39
ACCETTE, PICOZZINI, RONCOLE e MACETE	52
ASCE, MAZZESCURI e CUNEI	55
RASTRELLI, SARCHIATORI e AERATORI	61
SCOPE FOGLIE	69
RACCOLTA FRUTTA e TRATTAMENTO	78
NOVITÀ	84
FORCHE e VANGHE	90
ZAPPE, ZAPPINI, ATTREZZINI e FORBICI	94
MANICI FIBRA	101
MANICI MIX e LEGNO	115
ASTE TELESCOPICHE	123
ESPOSITORI	124
GUANTI	126
SOLLEVAMENTO e ANCORAGGIO	140

4 MARTELLERIA

20 MAZZE e  
PICCONI

24 SCALPELLI e  
LEVERINI

26 ARTICOLI PER  
PIETRA

27 **SECCHI, CAZZUOLE,  
SPATOLE e VARIE**

39 BADILI, PALE,  
RASCHIETTI  
e RASCHIAFANGO

52 ACCETTE, PICOZZINI,  
RONCOLE e MACETE

55 ASCE, MAZZESCURI  
e CUNEI

61 RASTRELLI,  
SARCHIATORI  
e AERATORI

69 SCOPE FOGLIE

78 RACCOLTA FRUTTA  
e TRATTAMENTO

84 NOVITÀ

90 FORCHE  
e VANGHE

94 ZAPPE, ZAPPINI,  
ATTREZZINI  
e FORBICI

101 MANICI FIBRA

115 MANICI MIX  
e LEGNO

123 ASTE  
TELESCOPICHE

124 ESPOSITORI

126 GUANTI

140 SOLLEVAMENTO  
e ANCORAGGIO

## Doppio metro in legno bianco/giallo a molla tipo professionale

Double wooden meter white/yellow with spring, professional model  
Double mètre en bois blanc/jaune avec ressort modèle professionnel

COD. ART.	L mm	BOX	COD. EAN - 13
<b>METM</b>	2000	10	80 3264633 706 8
Mercato / Markets / Marchés			



## Chiave a cricchetto per ponteggio

Pawl spanner holder  
Porte-clef à cliquet

COD. ART.	Ø	L mm	BOX	COD. EAN - 13
<b>CCP</b>	21/22	270	2	80 3264633 681 8
Mercato / Markets / Marchés				



## Chiave fissa per ponteggio

Fixed key for scaffolding  
Clef fixe pour échafaudage

COD. ART.	Ø	L mm	BOX	COD. EAN - 13
<b>CP</b>	21/22	530	6	80 3264633 687 0
Mercato / Markets / Marchés				



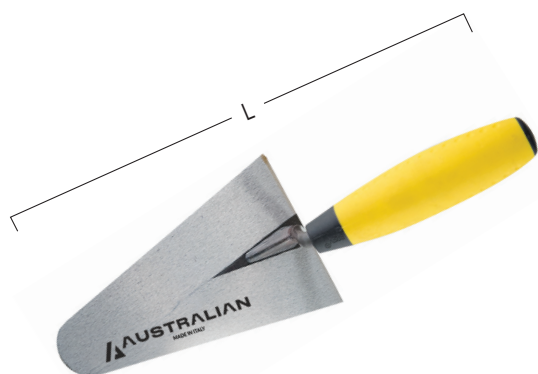

### Cazzuola tonda a punta stretta

Narrow tip round trowel  
Truelle ronde avec pointe étroite

COD. ART.	L mm	BOX	COD. EAN - 13
C16	160	6	80 5773372 095 0
C18	180	6	80 3264633 585 9
C20	200	6	80 3264633 586 6

Mercato / Markets / Marchés



### Cazzuola tonda traboccante

Round overflowing trowel  
Truelle ronde débordante

COD. ART.	L mm	BOX	COD. EAN - 13
CTT20	200	6	80 3264633 587 3
CTT22	220	6	80 3264633 588 0
CTT23	230	6	80 3264633 589 7

Mercato / Markets / Marchés



### Cazzuola a punta tonda

Round tip trowel  
Truelle avec pointe ronde

COD. ART.	L mm	BOX	COD. EAN - 13
CT16	160	6	80 3264633 590 3
CT18	180	6	80 3264633 591 0
CT19	190	6	80 3264633 592 7
CT20	200	6	80 3264633 593 4
CT21	210	6	80 5773372 086 8
CT22	220	6	80 3264633 608 5

Mercato / Markets / Marchés



### Cazzuola a punta quadra

Square tip trowel  
Truelle avec pointe carrée

COD. ART.	L mm	BOX	COD. EAN - 13
CQ16	160	6	80 3264633 615 3
CQ18	180	6	80 3264633 594 1
CQ19	190	6	80 3264633 595 8
CQ20	200	6	80 3264633 596 5

Mercato / Markets / Marchés

MARTELLERIA 4

MAZZE e  
PICCONI 20

SCALPELLI e  
LEVERINI 24

ARTICOLI PER  
PIETRA 26

**SECCHI, CAZZUOLE,  
SPATOLE e VARIE 27**

BADILI, PALE,  
RASCHIETTI  
e RASCHIAFANGO 39

ACCETTE, PICOZZINI,  
RONCOLE e MACETE 52

ASCE, MAZZESCURI  
e CUNEI 55

RASTRELLI,  
SARCHIATORI  
e AERATORI 61

SCOPE FOGLIE 69

RACCOLTA FRUTTA  
e TRATTAMENTO 78

NOVITÀ 84

FORCHE  
e VANGHE 90

ZAPPE, ZAPPINI,  
ATTREZZINI  
e FORBICI 94

MANICI FIBRA 101

MANICI MIX  
e LEGNO 115

ASTE  
TELESCOPICHE 123

ESPOSITORI 124

GUANTI 126

SOLLEVAMENTO  
e ANCORAGGIO 140

- 4 MARTELLERIA
- 20 MAZZE e PICCONI
- 24 SCALPELLI e LEVERINI
- 26 ARTICOLI PER PIETRA
- 27 **SECCHI, CAZZUOLE, SPATOLE e VARIE**
- 39 BADILI, PALE, RASCHIETTI e RASCHIAFANGO
- 52 ACCETTE, PICOZZINI, RONCOLE e MACETE
- 55 ASCE, MAZZESCURI e CUNEI
- 61 RASTRELLI, SARCHIATORI e AERATORI
- 69 SCOPE FOGLIE
- 78 RACCOLTA FRUTTA e TRATTAMENTO
- 84 NOVITÀ
- 90 FORCHE e VANGHE
- 94 ZAPPE, ZAPPINI, ATTREZZINI e FORBICI
- 101 MANICI FIBRA
- 115 MANICI MIX e LEGNO
- 123 ASTE TELESCOPICHE
- 124 ESPOSITORI
- 126 GUANTI
- 140 SOLLEVAMENTO e ANCORAGGIO



### Cazzolino a punta tonda

Round tip small trowel  
Petite truelle avec pointe ronde

COD. ART.	L mm	BOX	COD. EAN - 13
CAT14	140	6	80 3264633 597 2
Mercato / Markets / Marchés			



### Cazzolino a punta acuta

Sharp tip small trowel  
Petite truelle avec pointe aigue

COD. ART.	L mm	BOX	COD. EAN - 13
CAA14	140	6	80 3264633 598 9
Mercato / Markets / Marchés			



### Cazzolino a punta quadra

Square tip small trowel  
Petite truelle avec pointe carrée

COD. ART.	L mm	BOX	COD. EAN - 13
CAQ14	140	6	80 3264633 599 6
Mercato / Markets / Marchés			



### Cazzolino a foglia d'ulivo

Olive leaf small trowel  
Petite truelle feuille d'olivier

COD. ART.	L mm	BOX	COD. EAN - 13
CAU12	120	6	80 5773372 072 1
CAU14	140	6	80 5773372 073 8
Mercato / Markets / Marchés			



### Frattoni denti quadrati con manico in gomma

Finishing trowel with rubber haft  
Taloche avec poignée en gomme

COD. ART.	A mm	L mm	DENTI	BOX	COD. EAN - 13
F28125X7S	120	280	5X7	6	80 3264633 600 9
F28125X7D	120	280	5X7	6	80 3264633 603 0
F281210X10S	120	280	10X10	6	80 3264633 601 6
F281210X10D	120	280	10X10	6	80 3264633 604 7
F281212X12S	120	280	12X12	6	80 5773372 074 5
F281212X12D	120	280	12X12	6	80 5773372 075 2
Mercato / Markets / Marchés					



### Frattoni con manico in gomma

Finishing trowel with rubber haft  
Taloche avec poignée en gomme

COD. ART.	A mm	L mm	BOX	COD. EAN - 13
F2812	120	280	6	80 3264633 605 4
Mercato / Markets / Marchés				



### Frattoni con manico in legno

Finishing trowel with wooden handle  
Taloche avec manche en bois

COD. ART.	A mm	L mm	BOX	COD. EAN - 13
F4814	140	480	6	80 3264633 602 3
Mercato / Markets / Marchés				

NEW

### Spatola in acciaio INOX

Stainless steel putty knife  
Spatule en acier inoxydable

COD. ART.	L mm	BOX	COD. EAN - 13
SPI20	20	6	80 5773372 316 6
SPI30	30	6	80 5773372 317 3
SPI40	40	6	80 5773372 318 0
SPI50	50	6	80 5773372 319 7
SPI60	60	6	80 5773372 320 3
SPI80	80	6	80 5773372 321 0
SPI100	100	6	80 5773372 322 7
SPI120	120	6	80 5773372 323 4

Mercato / Markets / Marchés



MARTELLERIA 4

MAZZE e  
PICCONI 20

SCALPELLI e  
LEVERINI 24

ARTICOLI PER  
PIETRA 26

**SECCHI, CAZZUOLE,  
SPATOLE e VARIE 27**

NEW

### Spatola in poliammide - fibra vetro con impugnatura in gomma

Polyamide - fiberglass putty knife with rubber grip  
Spatule en polyamide - fibre de verre avec poignée en caoutchouc

COD. ART.	L mm	BOX	COD. EAN - 13
SPP30	30	6	80 5773372 324 1
SPP45	45	6	80 5773372 325 8
SPP60	60	6	80 5773372 326 5
SPP90	90	6	80 5773372 327 2
SPP120	120	6	80 5773372 328 9

Mercato / Markets / Marchés



BADILI, PALE,  
RASCHIETTI  
e RASCHIAFANGO 39

ACCETTE, PICOZZINI,  
RONCOLE e MACETE 52

ASCE, MAZZESCURI  
e CUNEI 55

RASTRELLI,  
SARCHIATORI  
e AERATORI 61

SCOPE FOGLIE 69

RACCOLTA FRUTTA  
e TRATTAMENTO 78

NOVITÀ 84

FORCHE  
e VANGHE 90

ZAPPE, ZAPPINI,  
ATTREZZINI  
e FORBICI 94

MANICI FIBRA 101

MANICI MIX  
e LEGNO 115

ASTE  
TELESCOPICHE 123

ESPOSITORI 124

GUANTI 126

SOLLEVAMENTO  
e ANCORAGGIO 140

NEW

### Spatola poliammide - fibra vetro dentata con impugnatura in gomma

Polyamide - fiberglass toothed putty knife with rubber grip  
Spatule en polyamide - fibre de verre avec poignée en caoutchouc

COD. ART.	L mm	BOX	COD. EAN - 13
SPD60	60	6	80 5773372 329 6
SPD90	90	6	80 5773372 330 2

Mercato / Markets / Marchés



NEW

### Spatola poliammide - fibra vetro

Polyamide - fiberglass scraper  
Spatule en polyamide - fibre de verre

COD. ART.	L mm	BOX	COD. EAN - 13
ESPP30	30	6	80 5773372 402 6
ESPP45	45	6	80 5773372 403 3
ESPP60	60	6	80 5773372 404 0
ESPP90	90	6	80 5773372 405 7
ESPP120	120	6	80 5773372 406 4

Mercato / Markets / Marchés



NEW

### Spatola poliammide - fibra vetro dentata

Polyamide - fiberglass toothed scraper  
Spatule en polyamide - fibre de verre denté

COD. ART.	L mm	BOX	COD. EAN - 13
ESPD60	60	6	80 5773372 407 1
ESPD90	90	6	80 5773372 407 1

Mercato / Markets / Marchés



4	MARTELLERIA
20	MAZZE e PICCONI
24	SCALPELLI e LEVERINI
26	ARTICOLI PER PIETRA
27	<b>SECCHI, CAZZUOLE, SPATOLE e VARIE</b>
39	BADILI, PALE, RASCHIETTI e RASCHIAFANGO
52	ACCETTE, PICOZZINI, RONCOLE e MACETE
55	ASCE, MAZZESCURI e CUNEI
61	RASTRELLI, SARCHIATORI e AERATORI
69	SCOPE FOGLIE
78	RACCOLTA FRUTTA e TRATTAMENTO
84	NOVITÀ
90	FORCHE e VANGHE
94	ZAPPE, ZAPPINI, ATTREZZINI e FORBICI
101	MANICI FIBRA
115	MANICI MIX e LEGNO
123	ASTE TELESCOPICHE
124	ESPOSITORI
126	GUANTI
140	SOLLEVAMENTO e ANCORAGGIO



### Espositore da banco completo di 84 spatole in poliammide - fibra di vetro miste con impugnatura in gomma

Table stand with 84 polyamide - fiberglass scrapers with rubber grip  
Presentoir de contour avec 84 spatules en polyamide - fibre de verre avec poignée en caoutchouc

COD. ART.	Hmm	BOX	COD. EAN - 13
ESP 84	680	1	80 5773372 719 5
Mercato / Markets / Marchés			



### Espositore da banco completo di 168 spatole in poliammide - fibra di vetro miste

Table stand with 168 polyamide - fiberglass scrapers  
Presentoir de contour avec 168 spatules en polyamide - fibre de verre

COD. ART.	Hmm	BOX	COD. EAN - 13
EESP 168	680	1	80 5773372 720 1
Mercato / Markets / Marchés			

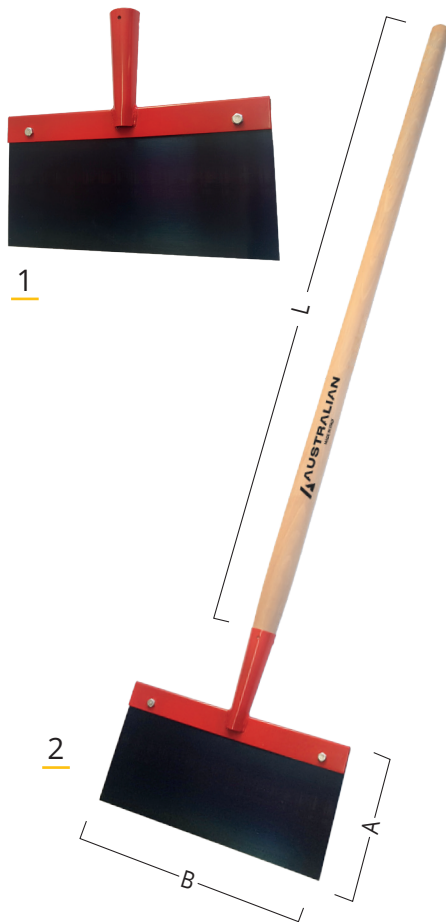

**NEW**

**1 Raschietto con lama temperata**

Hardened blade scraper  
Grattoir lame trempé

COD. ART.	Gr.	A mm	B mm	BOX	COD. EAN - 13
R1515	370	150	150	6	80 5773372 331 9
R3015	760	150	300	6	80 5773372 332 6
Mercato / Markets / Marchés					

**NEW**

**3 Raschiafango con lama temperata**

Hardened blade mud scraper  
Racloir de macon lame trempé

COD. ART.	Gr.	A mm	B mm	BOX	COD. EAN - 13
R45	910	450	120	6	80 5773372 341 8
Mercato / Markets / Marchés					

**NEW**

**2 Raschietto con lama temperata  
con manico in legno**

Hardened blade scraper with wooden handle  
Grattoir lame trempé avec manche en bois

COD. ART.	Gr.	L mm	A mm	B mm	BOX	COD. EAN - 13
R15 110 L	1040	1100	150	150	6	80 5773372 337 1
R30 110 L	1420	1100	150	300	6	80 5773372 339 5
Mercato / Markets / Marchés						

**NEW**

**4 Raschiafango con lama temperata  
con manico ultraleggero in fibra di vetro**

Hardened blade scraper with ultralight handle  
Racloir de macon lame trempé avec manche creux super léger

COD. ART.	Gr.	L mm	A mm	B mm	BOX	COD. EAN - 13
R45 140 P	1680	1400	450	120	6	80 5773372 342 5
Mercato / Markets / Marchés						

**NEW**

**5 Raschiafango con lama temperata  
con manico in legno**

Hardened blade mud scraper with wooden handle  
Racloir de macon lame trempé avec manche en bois

COD. ART.	Gr.	L mm	A mm	B mm	BOX	COD. EAN - 13
R45 140 L	1820	1400	450	120	6	80 5773372 343 2
Mercato / Markets / Marchés						

MARTELLERIA 4

MAZZE e PICCONI 20

SCALPELLI e LEVERINI 24

ARTICOLI PER PIETRA 26

SECCHI, CAZZUOLE, SPATOLE e VARIE 27

**BADILI, PALE, RASCHIETTI e RASCHIAFANGO 39**

ACCETTE, PICOZZINI, RONCOLE e MACETE 52

ASCE, MAZZESCURI e CUNEI 55

RASTRELLI, SARCHIATORI e AERATORI 61

SCOPE FOGLIE 69

RACCOLTA FRUTTA e TRATTAMENTO 78

NOVITÀ 84

FORCHE e VANGHE 90

ZAPPE, ZAPPINI, ATTREZZINI e FORBICI 94

MANICI FIBRA 101

MANICI MIX e LEGNO 115

ASTE TELESCOPICHE 123

ESPOSITORI 124

GUANTI 126

SOLLEVAMENTO e ANCORAGGIO 140

- 4 MARTELLERIA
- 20 MAZZE e PICCONI
- 24 SCALPELLI e LEVERINI
- 26 ARTICOLI PER PIETRA
- 27 SECCHI, CAZZUOLE, SPATOLE e VARIE
- 39 **BADILI, PALE, RASCHIETTI e RASCHIAFANGO**
- 52 ACCETTE, PICOZZINI, RONCOLE e MACETE
- 55 ASCE, MAZZESCURI e CUNEI
- 61 RASTRELLI, SARCHIATORI e AERATORI
- 69 SCOPE FOGLIE
- 78 RACCOLTA FRUTTA e TRATTAMENTO
- 84 NOVITÀ
- 90 FORCHE e VANGHE
- 94 ZAPPE, ZAPPINI, ATTREZZINI e FORBICI
- 101 MANICI FIBRA
- 115 MANICI MIX e LEGNO
- 123 ASTE TELESCOPICHE
- 124 ESPOSITORI
- 126 GUANTI
- 140 SOLLEVAMENTO e ANCORAGGIO

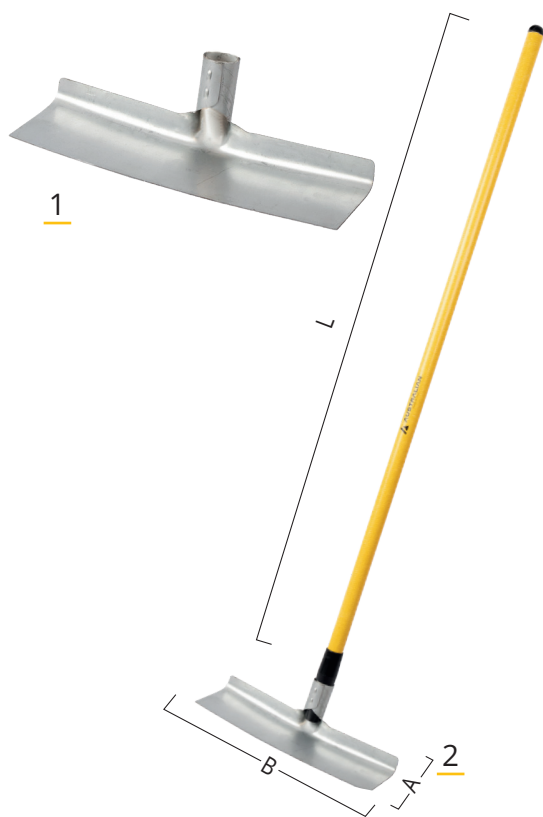

**1 Raschiafango zincato con lama temprata cm. 40**

Hardened blade mud scraper cm. 40  
Racloir de maçon lame trempé cm. 40

COD. ART.	Gr.	A mm	B mm	BOX	COD. EAN - 13
R40	760	400	115	6	80 5773372 737 9

Mercato / Markets / Marchés



**3 Raschiafango con lama temprata cm. 40 manico in legno**

Hardened blade mud scraper cm. 40 with wooden handle  
Racloir de maçon lame trempé cm. 40 avec manche en bois

COD. ART.	Gr.	L mm	A mm	B mm	BOX	COD. EAN - 13
R40 140L	1670	1400	400	115	6	80 5773372 739 3

Mercato / Markets / Marchés

**2 Raschiafango con lama temprata cm. 40 manico ultraleggero in fibra di vetro**

Hardened blade mud scraper cm. 40 with ultralight handle  
Racloir de maçon lame trempé cm. 40 avec manche creux super léger

COD. ART.	Gr.	L mm	A mm	B mm	BOX	COD. EAN - 13
R40 140P	1530	1400	400	115	6	80 5773372 738 6

Mercato / Markets / Marchés





**1 Badile acciaio temperato manico  
ultraleggero fibra di vetro**

Hardened steel shovel with ultralight handle  
Pelle en acier trempé avec manche creux super léger

COD. ART.	Gr.	L mm	A mm	B mm	BOX	COD. EAN - 13
BB 140 P	1720	1400	300	290	6	80 3264633 298 8
Mercato / Markets / Marchés						

**2 Badile acciaio temperato manico legno  
superleggero**

Steel shovel with wooden handle (very light)  
Pelle en acier avec manche en bois (très léger)

COD. ART.	Gr.	L mm	A mm	B mm	BOX	COD. EAN - 13
BB 140 LP	1550	1400	300	290	6	80 3264633 297 1
Mercato / Markets / Marchés						

**3 Badile acciaio temperato manico in  
frassino verniciato**

Hardened steel shovel with painted ash wood handle  
Pelle en acier trempé avec manche en bois de frêne verni

COD. ART.	Gr.	L mm	A mm	B mm	BOX	COD. EAN - 13
BB 140 LFV	1850	1400	300	290	6	80 5773372 066 0
Mercato / Markets / Marchés						

**4 Badile acciaio temperato con  
manico in legno**

Hardened steel shovel with wooden handle  
Pelle en acier trempé avec manche en bois

COD. ART.	Gr.	L mm	A mm	B mm	BOX	COD. EAN - 13
BB 140 L	1900	1400	300	290	6	80 3264633 286 5
Mercato / Markets / Marchés						

MARTELLERIA	4
MAZZE e PICCONI	20
SCALPELLI e LEVERINI	24
ARTICOLI PER PIETRA	26
SECCHI, CAZZUOLE, SPATOLE e VARIE	27
<b>BADILI, PALE, RASCHIETTI e RASCHIAFANGO</b>	<b>39</b>
ACCETTE, PICOZZINI, RONCOLE e MACETE	52
ASCE, MAZZESCURI e CUNEI	55
RASTRELLI, SARCHIATORI e AERATORI	61
SCOPE FOGLIE	69
RACCOLTA FRUTTA e TRATTAMENTO	78
NOVITÀ	84
FORCHE e VANGHE	90
ZAPPE, ZAPPINI, ATTREZZINI e FORBICI	94
MANICI FIBRA	101
MANICI MIX e LEGNO	115
ASTE TELESCOPICHE	123
ESPOSITORI	124
GUANTI	126
SOLLEVAMENTO e ANCORAGGIO	140

- 4 MARTELLERIA
- 20 MAZZE e PICCONI
- 24 SCALPELLI e LEVERINI
- 26 ARTICOLI PER PIETRA
- 27 SECCHI, CAZZUOLE, SPATOLE e VARIE
- 39 **BADILI, PALE, RASCHIELTI e RASCHIAFANGO**
- 52 ACCETTE, PICOZZINI, RONCOLE e MACETE
- 55 ASCE, MAZZESCURI e CUNEI
- 61 RASTRELLI, SARCHIATORI e AERATORI
- 69 SCOPE FOGLIE
- 78 RACCOLTA FRUTTA e TRATTAMENTO
- 84 NOVITÀ
- 90 FORCHE e VANGHE
- 94 ZAPPE, ZAPPINI, ATTREZZINI e FORBICI
- 101 MANICI FIBRA
- 115 MANICI MIX e LEGNO
- 123 ASTE TELESCOPICHE
- 124 ESPOSITORI
- 126 GUANTI
- 140 SOLLEVAMENTO e ANCORAGGIO



**5 Badile acciaio con manico ultraleggero in fibra di vetro**

Steel shovel with ultralight handle  
Pelle en acier avec manche creux super léger

COD. ART.	Gr.	L mm	A mm	B mm	BOX	COD. EAN - 13
<b>BE 140 P</b>	1720	1400	300	290	6	80 3264633 924 6

Mercato / Markets / Marchés

**8 Badile acciaio zincato temprato con manico in frassino verniciato**

Galvanized hardened steel shovel with painted ash wood handle  
Pelle en acier galvanisé trempé avec manche en bois de frêne verni

COD. ART.	Gr.	L mm	A mm	B mm	BOX	COD. EAN - 13
<b>BBZ 140 LFV</b>	1900	1400	300	290	6	80 5773372 067 7

Mercato / Markets / Marchés

**6 Badile in acciaio con manico in legno**

Steel shovel with wooden handle  
Pelle en acier avec manche en bois

COD. ART.	Gr.	L mm	A mm	B mm	BOX	COD. EAN - 13
<b>BE 140 L</b>	1900	1400	300	290	6	80 3264633 266 7

Mercato / Markets / Marchés

**9 Badile acciaio zincato temprato con manico in legno**

Galvanized hardened steel shovel with wooden handle  
Pelle en acier galvanisé trempé avec manche en bois

COD. ART.	Gr.	L mm	A mm	B mm	BOX	COD. EAN - 13
<b>BBZ 140 L</b>	1900	1400	300	290	6	80 3264633 690 0

Mercato / Markets / Marchés

**7 Badile in acciaio zincato temperato con manico ultraleggero in fibra di vetro**

Galvanized hardened steel shovel with ultralight handle  
Pelle en acier galvanisé trempé avec manche creux super léger

COD. ART.	Gr.	L mm	A mm	B mm	BOX	COD. EAN - 13
<b>BBZ 140 P</b>	1720	1400	300	290	6	80 3264633 927 7

Mercato / Markets / Marchés



**1 Badile in alluminio temperato "avio" con manico ultraleggero in fibra di vetro**

Hardened aluminium shovel with ultralight handle  
Pelle en aluminium trempé avec manche creux super léger

COD. ART.	Gr.	L mm	A mm	B mm	BOX	COD. EAN - 13
BA 140 P	1220	1400	300	290	6	80 3264633 926 0
Mercato / Markets / Marchés						

**2 Badile in alluminio temperato "avio" con manico in legno superleggero verniciato**

Aluminium shovel with wooden handle painted (very light)  
Pelle en aluminium avec manche en bois verni (très léger)

COD. ART.	Gr.	L mm	A mm	B mm	BOX	COD. EAN - 13
BA 140 LPV	1200	1400	300	290	6	80 3264633 322 0
Mercato / Markets / Marchés						

**3 Badile in alluminio manico ultraleggero in fibra di vetro**

Aluminium shovel with ultralight handle  
Pelle en aluminium avec manche creux super léger

COD. ART.	Gr.	L mm	A mm	B mm	BOX	COD. EAN - 13
BAE 140 P	1220	1400	300	290	6	80 3264633 923 9
Mercato / Markets / Marchés						

**4 Badile in alluminio manico in legno superleggero**

Aluminium shovel with wooden handle (very light)  
Pelle en aluminium avec manche en bois (très léger)

COD. ART.	Gr.	L mm	A mm	B mm	BOX	COD. EAN - 13
BA E 140 LP	1220	1400	300	290	6	80 3264633 287 2
Mercato / Markets / Marchés						

MARTELLERIA	4
MAZZE e PICCONI	20
SCALPELLI e LEVERINI	24
ARTICOLI PER PIETRA	26
SECCHI, CAZZUOLE, SPATOLE e VARIE	27
<b>BADILI, PALE, RASCHIETTI e RASCHIAFANGO</b>	<b>39</b>
ACCETTE, PICOZZINI, RONCOLE e MACETE	52
ASCE, MAZZESCURI e CUNEI	55
RASTRELLI, SARCHIATORI e AERATORI	61
SCOPE FOGLIE	69
RACCOLTA FRUTTA e TRATTAMENTO	78
NOVITÀ	84
FORCHE e VANGHE	90
ZAPPE, ZAPPINI, ATTREZZINI e FORBICI	94
MANICI FIBRA	101
MANICI MIX e LEGNO	115
ASTE TELESCOPICHE	123
ESPOSITORI	124
GUANTI	126
SOLLEVAMENTO e ANCORAGGIO	140

- 4 MARTELLERIA
- 20 MAZZE e PICCONI
- 24 SCALPELLI e LEVERINI
- 26 ARTICOLI PER PIETRA
- 27 SECCHI, CAZZUOLE, SPATOLE e VARIE
- 39 BADILI, PALE, RASCHIETTI e RASCHIAFANGO**
- 52 ACCETTE, PICOZZINI, RONCOLE e MACETE
- 55 ASCE, MAZZESCURI e CUNEI
- 61 RASTRELLI, SARCHIATORI e AERATORI
- 69 SCOPE FOGLIE
- 78 RACCOLTA FRUTTA e TRATTAMENTO
- 84 NOVITÀ
- 90 FORCHE e VANGHE
- 94 ZAPPE, ZAPPINI, ATTREZZINI e FORBICI
- 101 MANICI FIBRA
- 115 MANICI MIX e LEGNO
- 123 ASTE TELESCOPICHE
- 124 ESPOSITORI
- 126 GUANTI
- 140 SOLLEVAMENTO e ANCORAGGIO



**5 Badile acciaio tipo Cesena con manico ultraleggero fibra di vetro**  
 Cesena steel shovel with ultralight fibreglass handle  
 Pelle Cesena en acier avec manche creux super léger

COD. ART.	Gr.	L mm	A mm	B mm	BOX	COD. EAN - 13
<b>BC 140 P</b>	1400	1400	220	270	6	80 5773372 068 4
Mercato / Markets / Marchés						

**6 Badile acciaio tipo Cesena con manico in legno**  
 Cesena steel shovel with wooden handle  
 Pelle Cesena en acier avec manche en bois

COD. ART.	Gr.	L mm	A mm	B mm	BOX	COD. EAN - 13
<b>BC 140 LE</b>	1800	1400	220	270	6	80 5773372 069 1
Mercato / Markets / Marchés						

**7 Badile tondo temperato "muso di bue" con manico ultraleggero in fibra di vetro**  
 Rounded hardened shovel "bull's muzzle" with ultralight handle  
 Pelle ronde trempée « museau de boeuf » avec manche creux super léger

COD. ART.	Gr.	L mm	A mm	B mm	BOX	COD. EAN - 13
<b>BB 140 MB P</b>	1650	1400	290	280	6	80 3264633 930 7
Mercato / Markets / Marchés						

**8 Badile tondo "muso di bue" con manico legno**  
 Rounded shovel "bull's muzzle" with wood handle  
 Pelle rond "museau de boeuf" avec manche en bois

COD. ART.	Gr.	L mm	A mm	B mm	BOX	COD. EAN - 13
<b>BB 140 L MB</b>	1800	1400	290	280	6	80 3264633 697 9
Mercato / Markets / Marchés						

**9 Badile quadrato in acciaio temperato con manico ultraleggero in fibra di vetro**  
 Square hardened steel shovel with ultralight handle  
 Pelle carrée en acier trempé avec manche creux super léger

COD. ART.	Gr.	L mm	A mm	B mm	BOX	COD. EAN - 13
<b>BB 140 Q P</b>	1700	1400	290	280	6	80 3264633 931 4
Mercato / Markets / Marchés						

**10 Badile quadrato in acciaio temperato con manico legno**  
 Squared hardened steel shovel with wood handle  
 Pelle carrée en acier trempé avec manche en bois

COD. ART.	Gr.	L mm	A mm	B mm	BOX	COD. EAN - 13
<b>BB 140 L Q</b>	1850	1400	290	280	6	80 3264633 699 3
Mercato / Markets / Marchés						



**1 Badile «collo di cigno» con manico ultraleggero in fibra di vetro**

Swan neck shovel with ultralight handle  
Pelle à col de cygne avec manche creux super léger

COD. ART.	Gr.	L mm	A mm	B mm	BOX	COD. EAN - 13
BF 110/27 P	1760	1100	280	270	6	80 3264633 928 4
BF 110/29 P	1850	1100	280	290	6	80 3264633 929 1

Mercato / Markets / Marchés

**2 Badile «collo di cigno» con manico vuoto**

Swan neck shovel with empty handle  
Pelle à col de cygne avec manche creux

COD. ART.	Gr.	L mm	A mm	B mm	BOX	COD. EAN - 13
BF 115/27 V	1930	1150	280	270	6	80 3264633 694 8
BF 115/29 V	2000	1150	280	290	6	80 3264633 695 5

Mercato / Markets / Marchés

**3 Badile «collo di cigno» con manico fibra di vetro (impugnatura in gomma)**

Swan neck shovel with synthetic handle, rubber haft  
Pelle à col de cygne avec manche trimatière

COD. ART.	Gr.	L mm	A mm	B mm	BOX	COD. EAN - 13
BF 110/27 G	2280	1100	280	270	6	80 3264633 692 4
BF 110/29 G	2370	1100	280	290	6	80 3264633 693 1

Mercato / Markets / Marchés

**4 Badile «collo di cigno» con manico in legno**

Swan neck shovel with wooden handle  
Pelle à col de cygne avec manche en bois

COD. ART.	Gr.	L mm	A mm	B mm	BOX	COD. EAN - 13
BF 110/27 LE	1700	1400	290	270	6	80 5773372 070 7
BF 110/29 LE	1850	1400	300	290	6	80 5773372 071 4

Mercato / Markets / Marchés

**5 Badile modello «Est Europa» con manico in legno**

East European type shovel with wooden handle  
Pelle type Europe de l'est avec manche en bois

COD. ART.	Gr.	L mm	A mm	B mm	BOX	COD. EAN - 13
BU 140 L	1860	1400	280	230	6	80 5773372 734 8

Mercato / Markets / Marchés

**6 Badile modello «Est Europa» con manico in fibra di vetro**

East European type shovel with ultralight fiberglass handle  
Pelle type Europe de l'est avec manche ultraléger en fibre de verre

COD. ART.	Gr.	L mm	A mm	B mm	BOX	COD. EAN - 13
BU 140 P	1720	1400	280	230	6	80 5773372 735 5

Mercato / Markets / Marchés

MARTELLERIA	4
MAZZE e PICCONI	20
SCALPELLI e LEVERINI	24
ARTICOLI PER PIETRA	26
SECCHI, CAZZUOLE, SPATOLE e VARIE	27
<b>BADILI, PALE, RASCHIETTI e RASCHIAFANGO</b>	<b>39</b>
ACCETTE, PICOZZINI, RONCOLE e MACETE	52
ASCE, MAZZESCURI e CUNEI	55
RASTRELLI, SARCHIATORI e AERATORI	61
SCOPE FOGLIE	69
RACCOLTA FRUTTA e TRATTAMENTO	78
NOVITÀ	84
FORCHE e VANGHE	90
ZAPPE, ZAPPINI, ATTREZZINI e FORBICI	94
MANICI FIBRA	101
MANICI MIX e LEGNO	115
ASTE TELESCOPICHE	123
ESPOSITORI	124
GUANTI	126
SOLLEVAMENTO e ANCORAGGIO	140

4 MARTELLERIA

 20 MAZZE e  
PICCONI

 24 SCALPELLI e  
LEVERINI

 26 ARTICOLI PER  
PIETRA

 27 SECCHI, CAZZUOLE,  
SPATOLE e VARIE

 39 **BADILI, PALE,  
RASCHIETTI  
e RASCHIAFANGO**

 52 ACCETTE, PICOZZINI,  
RONCOLE e MACETE

 55 ASCE, MAZZESCURI  
e CUNEI

 61 RASTRELLI,  
SARCHIATORI  
e AERATORI

69 SCOPE FOGLIE

 78 RACCOLTA FRUTTA  
e TRATTAMENTO

84 NOVITÀ

 90 FORCHE  
e VANGHE

 94 ZAPPE, ZAPPINI,  
ATTREZZINI  
e FORBICI

101 MANICI FIBRA

 115 MANICI MIX  
e LEGNO

 123 ASTE  
TELESCOPICHE

124 ESPOSITORI

126 GUANTI

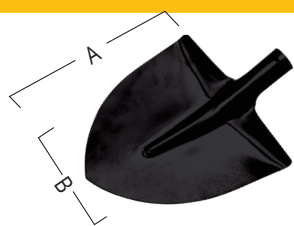
 140 SOLLEVAMENTO  
e ANCORAGGIO

**Badile acciaio**

 Hardened steel shovel  
Pelle en acier trempé

COD. ART.	Gr.	A mm	B mm	BOX	COD. EAN - 13
BE	950 ca	300	290	12	80 3264633 354 1

Mercato / Markets / Marchés

**Badile acciaio temperato**

 Hardened steel shovel  
Pelle en acier trempé

COD. ART.	Gr.	A mm	B mm	BOX	COD. EAN - 13
BB	950 ca	300	290	12	80 3264633 285 8

Mercato / Markets / Marchés

**Badile acciaio temperato muso di bue**

 "Bull's muzzle" type hardened steel shovel  
Pelle en acier trempé "museau de boeuf"

COD. ART.	Gr.	A mm	B mm	BOX	COD. EAN - 13
BB MB	900 ca	280	290	12	80 3264633 700 6

Mercato / Markets / Marchés

**Badile acciaio  
temperato quadrato**

 Squared tempered steel shovel  
Pelle carrée en acier trempé

COD. ART.	Gr.	A mm	B mm	BOX	COD. EAN - 13
BB Q	900 ca	280	290	12	80 3264633 701 3

Mercato / Markets / Marchés

**Badile in acciaio  
tipo "Cesena"**

 "Cesena" steel shovel  
Pelle "Cesena" en acier

COD. ART.	Gr.	A mm	B mm	BOX	COD. EAN - 13
BC	850	270	230		80 5773372 593 1

Mercato / Markets / Marchés

**Badile collo di cigno**

 Swan neck shovel  
Pelle à col de cygne

COD. ART.	Gr.	A mm	B mm	BOX	COD. EAN - 13
BF 27	1180	280	270	12	80 3264633 703 7
BF 29	1250	280	290	12	80 3264633 704 4

Mercato / Markets / Marchés

**Badile acciaio temprato zincato**

 Galvanized hardened steel shovel  
Pelle en acier galvanisé trempé

COD. ART.	Gr.	A mm	B mm	BOX	COD. EAN - 13
BBZ	950 ca	300	290	12	80 3264633 702 0

Mercato / Markets / Marchés

**Badile in alluminio temperato Avio**

 Aluminium shovel  
Pelle en aluminium

COD. ART.	Gr.	A mm	B mm	BOX	COD. EAN - 13
BA	450	300	290	12	80 3264633 366 4

Mercato / Markets / Marchés

**Badile in alluminio**

 Aluminium shovel  
Pelle en aluminium

COD. ART.	Gr.	A mm	B mm	BOX	COD. EAN - 13
BA E	450	300	290	12	80 3264633 367 1

Mercato / Markets / Marchés

**Badile in acciaio  
modello Est Europa**

 East European type shovel  
Pelle type Est de l'Europe en acier

COD. ART.	Gr.	A mm	B mm	BOX	COD. EAN - 13
BU	950	280	230	12	80 5773372 736 2

Mercato / Markets / Marchés





MARTELLERIA	4
MAZZE e PICCONI	17
SCALPELLI e LEVERINI	24
ARTICOLI PER PIETRA	26
SECCHI, CAZZUOLE, SPATOLE e VARIE	30
BADILI, PALE, RASCHIETTI e RASCHIAFANGO	39
ACCETTE, PICOZZINI, RONCOLE e MACETE	51
ASCE, MAZZESCURI e CUNEI	54
RASTRELLI, SARCHIATORI e AERATORI	60
SCOPE FOGLIE	68
RACCOLTA FRUTTA e TRATTAMENTO	78
NOVITÀ	83
FORCHE e VANGHE	88
ZAPPE, ZAPPINI, ATTREZZINI e FORBICI	92
MANICI FIBRA	98
MANICI MIX e LEGNO	112
ASTE TELESCOPICHE	120
ESPOSITORI	121
GUANTI	123
SOLLEVAMENTO e ANCORAGGIO	138

- 4 MARTELLERIA
- 20 MAZZE e PICCONI
- 24 SCALPELLI e LEVERINI
- 26 ARTICOLI PER PIETRA
- 27 SECCHI, CAZZUOLE, SPATOLE e VARIE
- 39 **BADILI, PALE, RASCHIETTI e RASCHIAFANGO**
- 52 ACCETTE, PICOZZINI, RONCOLE e MACETE
- 55 ASCE, MAZZESCURI e CUNEI
- 61 RASTRELLI, SARCHIATORI e AERATORI
- 69 SCOPE FOGLIE
- 78 RACCOLTA FRUTTA e TRATTAMENTO
- 84 NOVITÀ
- 90 FORCHE e VANGHE
- 94 ZAPPE, ZAPPINI, ATTREZZINI e FORBICI
- 101 MANICI FIBRA
- 115 MANICI MIX e LEGNO
- 123 ASTE TELESCOPICHE
- 124 ESPOSITORI
- 126 GUANTI
- 140 SOLLEVAMENTO e ANCORAGGIO



### 1 Pala poliammide con manico ultraleggero in fibra di vetro

Polyamide fibreglass shovel with ultralight fibreglass handle  
Pelle en polyamide fibre de verre avec manche creux super léger

COD. ART.	L mm	A mm	B mm	BOX	COD. EAN - 13
130P99P	1300	420	350	6	80 5773372 035 6
Mercato / Markets / Marchés					

### 2 Pala poliammide con manico in legno

Polyamide fibreglass shovel with wooden handle  
Pelle en polyamide fibre de verre avec manche en bois

COD. ART.	L mm	A mm	B mm	BOX	COD. EAN - 13
130P99L	1300	420	350	6	80 3264633 618 4
Mercato / Markets / Marchés					

### 3 Pala alluminio con manico ultraleggero in fibra di vetro

Aluminium shovel with ultralight fibreglass handle  
Pelle en aluminium avec manche creux super léger

COD. ART.	L mm	A mm	B mm	BOX	COD. EAN - 13
130 PA P	1300	400	330	6	80 3264633 495 1
110 PA P	1100	400	330	6	80 3264633 496 8
Mercato / Markets / Marchés					

### 4 Pala alluminio con manico in legno

Aluminium shovel with wooden handle  
Pelle en aluminium avec manche en bois

COD. ART.	L mm	A mm	B mm	BOX	COD. EAN - 13
140 PA L	1400	400	330	6	80 3264633 497 5
Mercato / Markets / Marchés					

### 5 Pala poliammide con manico ultraleggero in fibra di vetro e impugnatura a «D»

Polyamide fibreglass shovel with ultralight fibreglass handle and «D» Shapes grip  
Pelle en polyamide fibre de verre avec manche creux super léger et poigner à «D»

COD. ART.	L mm	A mm	B mm	BOX	COD. EAN - 13
90P99DP	900	420	350	3	80 5773372 718 8
Mercato / Markets / Marchés					

### 6 Pala alluminio con manico ultraleggero in fibra di vetro e impugnatura a «D»

Aluminium fibreglass shovel with ultralight fibreglass handle and «D» Shapes grip  
Pelle en aluminium fibre de verre avec manche creux super léger et poigner à «D»

COD. ART.	L mm	A mm	B mm	BOX	COD. EAN - 13
90PADP	900	400	330	3	80 5773372 722 5
Mercato / Markets / Marchés					





**1 Pala a cucchiaio multiuso in polipropilene con manico ultraleggero in fibra di vetro**

Polypropylene spoon shaped shovel with ultralight fibreglass handle  
Pelle en polypropylène à cuillère avec manche creux super léger

COD. ART.	L mm	A mm	B mm	BOX	COD. EAN - 13
130 PC P	1300	400	370	6	80 3264633 863 8
140 PC P	1400	400	370	6	80 3264633 864 5

Mercato / Markets / Marchés

**2 Pala a cucchiaio multiuso in polipropilene con manico in legno**

Polypropylene spoon shaped shovel with wooden handle  
Pelle en polypropylène à cuillère avec manche en bois

COD. ART.	L mm	A mm	B mm	BOX	COD. EAN - 13
140 PC L	1400	400	370	6	80 3264633 865 2

Mercato / Markets / Marchés

**3 Pala a cucchiaio multiuso in polipropilene con manico ultraleggero in fibra di vetro impugnatura "T"**

Polypropylene spoon shovel with "T" shaped ultralight fibreglass handle  
Pelle en polyprop. à cuillère avec manche creux super léger à "T" en fibre de verre

COD. ART.	L mm	A mm	B mm	BOX	COD. EAN - 13
90 PC TP	900	400	370	6	80 3264633 984 0

Mercato / Markets / Marchés

**4 Pala a cucchiaio multiuso in polipropilene con manico curvo in resina impugnatura "T"**

Polypropylene spoon shaped shovel with curved resin "T" shaped handle  
Pelle en polypropylène à cuillère avec manche cintré à "T" en resine

COD. ART.	L mm	A mm	B mm	BOX	COD. EAN - 13
95 PC TBG	950	400	370	6	80 3264633 985 7

Mercato / Markets / Marchés

**5 Pala a cucchiaio multiuso in polipropilene profilo in alluminio con manico ultraleggero in fibra di vetro**

Polyprop. spoon shovel with aluminium profile and ultralight fibreglass handle  
Pelle en polyprop. à cuillère avec bord en aluminium et manche creux super léger

COD. ART.	L mm	A mm	B mm	BOX	COD. EAN - 13
130 PCR P	1300	400	370	6	80 3264633 867 6
140 PCR P	1400	400	370	6	80 3264633 868 3

Mercato / Markets / Marchés

**6 Pala a cucchiaio multiuso in polipropilene, profilo in alluminio con manico in legno**

Polypropylene spoon shaped shovel with aluminium profile with wooden handle  
Pelle en polypropylène à cuillère avec bord en aluminium avec manche en bois

COD. ART.	L mm	A mm	B mm	BOX	COD. EAN - 13
140 PCR L	1630	400	370	6	80 3264633 869 0

Mercato / Markets / Marchés

MARTELLERIA	4
MAZZE e PICCONI	20
SCALPELLI e LEVERINI	24
ARTICOLI PER PIETRA	26
SECCHI, CAZZUOLE, SPATOLE e VARIE	27
<b>BADILI, PALE, RASCHIETTI e RASCHIAFANGO</b>	<b>39</b>
ACCETTE, PICOZZINI, RONCOLE e MACETE	52
ASCE, MAZZESCURI e CUNEI	55
RASTRELLI, SARCHIATORI e AERATORI	61
SCOPE FOGLIE	69
RACCOLTA FRUTTA e TRATTAMENTO	78
NOVITÀ	84
FORCHE e VANGHE	90
ZAPPE, ZAPPINI, ATTREZZINI e FORBICI	94
MANICI FIBRA	101
MANICI MIX e LEGNO	115
ASTE TELESCOPICHE	123
ESPOSITORI	124
GUANTI	126
SOLLEVAMENTO e ANCORAGGIO	140

- 4 MARTELLERIA
- 20 MAZZE e PICCONI
- 24 SCALPELLI e LEVERINI
- 26 ARTICOLI PER PIETRA
- 27 SECCHI, CAZZUOLE, SPATOLE e VARIE
- 39 **BADILI, PALE, RASCHIETTI e RASCHIAFANGO**
- 52 ACCETTE, PICOZZINI, RONCOLE e MACETE
- 55 ASCE, MAZZESCURI e CUNEI
- 61 RASTRELLI, SARCHIATORI e AERATORI
- 69 SCOPE FOGLIE
- 78 RACCOLTA FRUTTA e TRATTAMENTO
- 84 NOVITÀ
- 90 FORCHE e VANGHE
- 94 ZAPPE, ZAPPINI, ATTREZZINI e FORBICI
- 101 MANICI FIBRA
- 115 MANICI MIX e LEGNO
- 123 ASTE TELESCOPICHE
- 124 ESPOSITORI
- 126 GUANTI
- 140 SOLLEVAMENTO e ANCORAGGIO



**7 Pala a cucchiaio multiuso in polipropilene, profilo in alluminio con manico ultraleggero in fibra di vetro impugnatura "T"**

Polyprop. spoon shovel with aluminium profile with "T" ultralight handle  
 Pelle en polyprop. à cuillèr, bord en aluminium ,manche creux super léger à "T"

COD. ART.	L mm	A mm	B mm	BOX	COD. EAN - 13
90 PCR TP	900	400	370	6	80 3264633 499 9

Mercato / Markets / Marchés

**8 Pala a cucchiaio multiuso in polipropilene, profilo in alluminio con manico curvo in resina impugnatura "T"**

Polyprop. spoon shovel. aluminium profile with curved resin "T" handle  
 Pelle en polyprop. à cuillèr, bord en aluminium, manche cintré à "T" en resine

COD. ART.	L mm	A mm	B mm	BOX	COD. EAN - 13
95 PCR TBG	950	400	370	6	80 3264633 500 2

Mercato / Markets / Marchés

**9 Pala neve in polipropilene con manico ultraleggero in fibra di vetro**

Polypropylene snow shovel with ultralight fibreglass handle  
 Pelle pour neige en polypropylène avec manche creux super léger

COD. ART.	L mm	A mm	B mm	BOX	COD. EAN - 13
130 PN P	1300	370	450	6	80 3264633 871 3
140 PN P	1400	370	450	6	80 3264633 872 0

Mercato / Markets / Marchés

**10 Pala neve in polipropilene con manico in legno**

Polypropylene snow shovel with wooden handle  
 Pelle pour neige en polypropylène avec manche en bois

COD. ART.	L mm	A mm	B mm	BOX	COD. EAN - 13
140 PN L	1400	370	450	6	80 3264633 873 7

Mercato / Markets / Marchés

**11 Pala neve in polipropilene con profilo in alluminio con manico ultraleggero in fibra di vetro**

Polyprop. snow shovel, aluminium profile with ultralight fibreglass handle  
 Pelle pour neige en polyprop. bord en aluminium, manche creux super léger

COD. ART.	L mm	A mm	B mm	BOX	COD. EAN - 13
130 PNR P	1300	370	450	6	80 3264633 875 1
140 PNR P	1400	370	450	6	80 3264633 876 8

Mercato / Markets / Marchés

**12 Pala neve in polipropilene con profilo in alluminio con manico in legno**

Polypropylene snow shovel with aluminium profile with wooden handle  
 Pelle pour neige en polypropylène avec bord en aluminium avec manche en bois

COD. ART.	L mm	A mm	B mm	BOX	COD. EAN - 13
140 PNR L	1400	370	450	6	80 3264633 877 5



Mercato / Markets / Marchés



**Pala alluminio**

Aluminium shovel  
Pelle en aluminium

COD. ART.	Gr.	A mm	B mm	BOX	COD. EAN - 13
PA	900	400	330	12	80 3264633 498 2

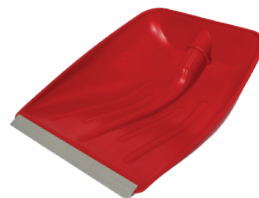

Mercato / Markets / Marchés  



**Pala a cucchiaio multiuso in polipropilene  
con profilo in alluminio**

Polypropylene spoon shaped shovel with aluminium profile  
Pelle en polypropylène à cuillère avec bord en aluminium

COD. ART.	Gr.	A mm	B mm	BOX	COD. EAN - 13
PCR	650	370	400	12	80 3264633 870 6



Mercato / Markets / Marchés  



**Pala poliammide**

Polyamide fibreglass shovel  
Pelle en polyamide fibre de verre

COD. ART.	Gr.	A mm	B mm	BOX	COD. EAN - 13
P99	900	420	350	6	80 5773372 036 3



Mercato / Markets / Marchés  



**Pala da neve in polipropilene**

Polypropylene snow shovel  
Pelle pour neige en polypropylène

COD. ART.	Gr.	A mm	B mm	BOX	COD. EAN - 13
PN	730	370	450	20	80 3264633 874 4



Mercato / Markets / Marchés  



**Pala a cucchiaio multiuso in polipropilene**

Polypropylene spoon shaped shovel  
Pelle en polypropylène à cuillère

COD. ART.	Gr.	A mm	B mm	BOX	COD. EAN - 13
PC	650	400	370	12	80 3264633 866 9

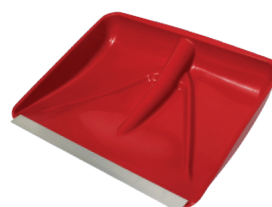

Mercato / Markets / Marchés  



**Pala neve in polipropilene con profilo  
in alluminio**

Polypropylene snow shovel with aluminium profile  
Pelle pour neige en polypropylène avec bord en aluminium

COD. ART.	Gr.	A mm	B mm	BOX	COD. EAN - 13
PNR	850	370	450	12	80 3264633 878 2

Mercato / Markets / Marchés  

MARTELLERIA 4

MAZZE e PICCONI 20

SCALPELLI e LEVERINI 24

ARTICOLI PER PIETRA 26

SECCHI, CAZZUOLE, SPATOLE e VARIE 27

**BADILI, PALE, RASCHIETTI e RASCHIAFANGO** 39

ACCETTE, PICOZZINI, RONCOLE e MACETE 52

ASCE, MAZZESCURI e CUNEI 55

RASTRELLI, SARCHIATORI e AERATORI 61

SCOPE FOGLIE 69

RACCOLTA FRUTTA e TRATTAMENTO 78

NOVITÀ 84

FORCHE e VANGHE 90

ZAPPE, ZAPPINI, ATTREZZINI e FORBICI 94

MANICI FIBRA 101

MANICI MIX e LEGNO 115

ASTE TELESCOPICHE 123

ESPOSITORI 124

GUANTI 126

SOLLEVAMENTO e ANCORAGGIO 140

- 4 MARTELLERIA
- 20 MAZZE e PICCONI
- 24 SCALPELLI e LEVERINI
- 26 ARTICOLI PER PIETRA
- 27 SECCHI, CAZZUOLE, SPATOLE e VARIE
- 39 BADILI, PALE, RASCHIETTI e RASCHIAFANGO
- 52 **ACCETTE, PICOZZINI, RONCOLE e MACETE**
- 55 ASCE, MAZZESCURI e CUNEI
- 61 RASTRELLI, SARCHIATORI e AERATORI
- 69 SCOPE FOGLIE
- 78 RACCOLTA FRUTTA e TRATTAMENTO
- 84 NOVITÀ
- 90 FORCHE e VANGHE
- 94 ZAPPE, ZAPPINI, ATTREZZINI e FORBICI
- 101 MANICI FIBRA
- 115 MANICI MIX e LEGNO
- 123 ASTE TELESCOPICHE
- 124 ESPOSITORI
- 126 GUANTI
- 140 SOLLEVAMENTO e ANCORAGGIO



**NEW** **Roncola forgiata con impugnatura in cuoio**  
 Forged billhook with leather handle  
 Crochet forgé avec manche en cuir

COD. ART.	Gr.	L mm	BOX	COD. EAN - 13
<b>RON231</b>	470	380	6	80 5773372 178 0
Mercato / Markets / Marchés				



**NEW** **Manarrese forgiato con manico in cuoio**  
 Double-edged billhook with leather handle  
 Mannarais forgé avec manche en cuir

COD. ART.	Gr.	L mm	BOX	COD. EAN - 13
<b>MANA298</b>	790	340	6	80 5773372 177 3
Mercato / Markets / Marchés				



**NEW** **Roncola Sardegna con impugnatura in legno**  
 "Sardegna" billhook with wooden handle  
 "Sardegna" crochet avec manche en bois

COD. ART.	Gr.	L mm	BOX	COD. EAN - 13
<b>RS80</b>	1020	1080	6	80 3264633 558 3
Mercato / Markets / Marchés				



**NEW** **Macete con impugnatura in legno**  
 Machete with wooden handle  
 Machette avec manche en bois

COD. ART.	Gr.	L mm	BOX	COD. EAN - 13
<b>MAC10L</b>	500	340	6	80 5773372 179 7
Mercato / Markets / Marchés				



**NEW** **Roncoletta forgiata con impugnatura in legno**  
 Forged small billhook with wooden handle  
 Petite crochet forgé avec manche en bois

COD. ART.	Gr.	L mm	BOX	COD. EAN - 13
<b>R14</b>	140	260	6	80 5773372 243 5
Mercato / Markets / Marchés				



**Falcia n°2**  
 Sickle N° 2  
 Serpe N°2

COD. ART.	Gr.	L mm	BOX	COD. EAN - 13
<b>F2</b>	300	410	6	80 5773372 244 2
Mercato / Markets / Marchés				



NEW

### Accetta con manico sagomato anima in fibra di vetro (impugnatura in gomma)

Hatchet with shaped glass fibre core handle (rubber haft)  
Hachette avec manche trimatière modelé

COD. ART.	Gr.	L mm	BOX	COD. EAN - 13
AS 400 G	400	370	6	80 5773372 192 6
AS 600 G	600	370	6	80 5773372 193 3
AS 800 G	800	400	6	80 5773372 190 2
AS 1000 G	1000	400	6	80 5773372 191 9
Mercato / Markets / Marchés				 EU



### Accetta con manico anima in fibra di vetro (impugnatura in gomma)

Hatchet with glass fibre core handle (rubber haft)  
Hachette avec manche trimatière

COD. ART.	Gr.	L mm	BOX	COD. EAN - 13
AP 0637 G	600	370	6	80 3264633 175 2
Mercato / Markets / Marchés				 EU



### Accetta tipo tedesco con manico in legno

German hatchet with wooden handle  
Hachette avec manche en bois

COD. ART.	Gr.	L mm	BOX	COD. EAN - 13
AT 0636 LE	600	360	6	80 3264633 814 0
AT 0838 LE	800	380	6	80 3264633 815 7
AT 1040 LE	1000	400	6	80 3264633 820 1
Mercato / Markets / Marchés				 EU



### Accetta con manico in legno Mix

Hatchet with wooden handle Mix  
Hachette avec manche en bois Mix

COD. ART.	Gr.	L mm	BOX	COD. EAN - 13
AP 0637 L/MIX	600	370	6	80 3264633 210 0
Mercato / Markets / Marchés				 EU



### Accetta antisfilamento con manico sagomato in legno

Hatchet with shaped wooden handle  
Hachette avec manche en bois modelé

COD. ART.	Gr.	L mm	BOX	COD. EAN - 13
AS 400 LE	400	370	6	80 5773372 344 9
AS 600 LE	600	370	6	80 5773372 345 6
AS 800 LE	800	400	6	80 5773372 346 3
AS 1000 LE	1000	400	6	80 5773372 347 0
Mercato / Markets / Marchés				 EU



### Accetta con manico in legno

Hatchet with wooden handle  
Hachette avec manche en bois

COD. ART.	Gr.	L mm	BOX	COD. EAN - 13
AP 0637 LE	600	370	6	80 3264633 211 7
Mercato / Markets / Marchés				 EU

MARTELLERIA 4

MAZZE e PICCONI 20

SCALPELLI e LEVERINI 24

ARTICOLI PER PIETRA 26

SECCHI, CAZZUOLE, SPATOLE e VARIE 27

BADILI, PALE, RASCHIETTI e RASCHIAFANGO 39

ACCETTE, PICOZZINI, RONCOLE e MACETE 52

ASCE, MAZZESCURI e CUNEI 55

RASTRELLI, SARCHIATORI e AERATORI 61

SCOPE FOGLIE 69

RACCOLTA FRUTTA e TRATTAMENTO 78

NOVITÀ 84

FORCHE e VANGHE 90

ZAPPE, ZAPPINI, ATTREZZINI e FORBICI 94

MANICI FIBRA 101

MANICI MIX e LEGNO 115

ASTE TELESCOPICHE 123

ESPOSITORI 124

GUANTI 126

SOLLEVAMENTO e ANCORAGGIO 140

- 4 MARTELLERIA
- 20 MAZZE e PICCONI
- 24 SCALPELLI e LEVERINI
- 26 ARTICOLI PER PIETRA
- 27 SECCHI, CAZZUOLE, SPATOLE e VARIE
- 39 BADILI, PALE, RASCHIETTI e RASCHIAFANGO
- 52 **ACCETTE, PICOZZINI, RONCOLE e MACETE**
- 55 ASCE, MAZZESCURI e CUNEI
- 61 RASTRELLI, SARCHIATORI e AERATORI
- 69 SCOPE FOGLIE
- 78 RACCOLTA FRUTTA e TRATTAMENTO
- 84 NOVITÀ
- 90 FORCHE e VANGHE
- 94 ZAPPE, ZAPPINI, ATTREZZINI e FORBICI
- 101 MANICI FIBRA
- 115 MANICI MIX e LEGNO
- 123 ASTE TELESCOPICHE
- 124 ESPOSITORI
- 126 GUANTI
- 140 SOLLEVAMENTO e ANCORAGGIO



### Accetta martello con manico anima in fibra di vetro (impugnatura in gomma)

Hatchet French pattern with glass fibre core handle (rubber haft)  
Hachette à tête avec manche trimatière

COD. ART.	Gr.	L mm	BOX	COD. EAN - 13
AA 0537 G	700	370	6	80 3264633 119 6
Mercato / Markets / Marchés				



### Picozzino gessatore con manico anima in fibra di vetro (impugnatura in gomma)

Gipserbeil hatchet with glass fibre core handle (rubber haft)  
Hachette de charpentier avec manche trimatière

COD. ART.	Gr.	L mm	BOX	COD. EAN - 13
HP 0637 G	600	370	6	80 3264633 261 2
Mercato / Markets / Marchés				



### Accetta martello con manico in legno Mix

Hatchet French pattern with wooden handle Mix  
Hachette marteau avec manche en bois Mix

COD. ART.	Gr.	L mm	BOX	COD. EAN - 13
AA 0537 L/MIX	700	370	6	80 3264633 439 5
Mercato / Markets / Marchés				



### Picozzino gessatore con manico in legno Mix

Gipserbeil hatchet with wooden handle Mix  
Hachette de charpentier avec manche en bois Mix

COD. ART.	Gr.	L mm	BOX	COD. EAN - 13
HP 0637 L/MIX	600	370	6	80 3264633 437 1
Mercato / Markets / Marchés				



### Accetta martello con manico in legno

Hatchet French pattern with wooden handle  
Hachette marteau avec manche en bois

COD. ART.	Gr.	L mm	BOX	COD. EAN - 13
AA 0537 LE	700	370	6	80 3264633 440 1
Mercato / Markets / Marchés				



### Picozzino gessatore con manico in legno

Gipserbeil hatchet with wooden handle  
Hachette de charpentier avec manche en bois

COD. ART.	Gr.	L mm	BOX	COD. EAN - 13
HP 0637 LE	600	370	6	80 3264633 438 8
Mercato / Markets / Marchés				

### Ascia con manico sagomato anima in fibra di vetro (impugnatura in gomma)

Cutting or splitting axe with shaped glass fibre core handle (rubber haft)  
Hache avec manche trimatière

NEW

COD. ART.	Gr.	L mm	BOX	COD. EAN - 13
AS 1200 G	1200	850	6	80 5773372 187 2
AS 1400 G	1400	850	6	80 5773372 188 9
AS 1800 G	1800	850	6	80 5773372 189 6
Mercato / Markets / Marchés				



MARTELLERIA 4

MAZZE e PICCONI 20

SCALPELLI e LEVERINI 24

ARTICOLI PER PIETRA 26

SECCHI, CAZZUOLE, SPATOLE e VARIE 27

BADILI, PALE, RASCHIETTI e RASCHIAFANGO 39

ACCETTE, PICOZZINI, RONCOLE e MACETE 52

**ASCE, MAZZESCURI e CUNEI 55**

RASTRELLI, SARCHIATORI e AERATORI 61

SCOPE FOGLIE 69

RACCOLTA FRUTTA e TRATTAMENTO 78

NOVITÀ 84

FORCHE e VANGHE 90

ZAPPE, ZAPPINI, ATTREZZINI e FORBICI 94

MANICI FIBRA 101

MANICI MIX e LEGNO 115

ASTE TELESCOPICHE 123

ESPOSITORI 124

GUANTI 126

SOLLEVAMENTO e ANCORAGGIO 140

### Ascia tipo tedesco Din 7294 con manico sagomato in legno

German cutting or splitting axe with shaped wooden handle Din 7294  
Hache Allemande avec manche en bois modelé Din 7294

NEW

COD. ART.	Gr.	L mm	BOX	COD. EAN - 13
AS 1600 LE	1600	800	6	80 5773372 201 5
Mercato / Markets / Marchés				



### Ascia antisfilamento con manico sagomato in legno

Cutting or splitting axe with shaped wooden handle  
Hachette avec manche en bois modelé

NEW

COD. ART.	Gr.	L mm	BOX	COD. EAN - 13
AS 1200 LE	1200	900	6	80 5773372 348 7
AS 1400 LE	1400	900	6	80 5773372 349 4
AS 1800 LE	1800	900	6	80 5773372 350 0
Mercato / Markets / Marchés				



- 4 MARTELLERIA
- 20 MAZZE e PICCONI
- 24 SCALPELLI e LEVERINI
- 26 ARTICOLI PER PIETRA
- 27 SECCHI, CAZZUOLE, SPATOLE e VARIE
- 39 BADILI, PALE, RASCHIETTI e RASCHIAFANGO
- 52 ACCETTE, PICOZZINI, RONCOLE e MACETE
- 55 **ASCE, MAZZESCURI e CUNEI**
- 61 RASTRELLI, SARCHIATORI e AERATORI
- 69 SCOPE FOGLIE
- 78 RACCOLTA FRUTTA e TRATTAMENTO
- 84 NOVITÀ
- 90 FORCHE e VANGHE
- 94 ZAPPE, ZAPPINI, ATTREZZINI e FORBICI
- 101 MANICI FIBRA
- 115 MANICI MIX e LEGNO
- 123 ASTE TELESCOPICHE
- 124 ESPOSITORI
- 126 GUANTI
- 140 SOLLEVAMENTO e ANCORAGGIO

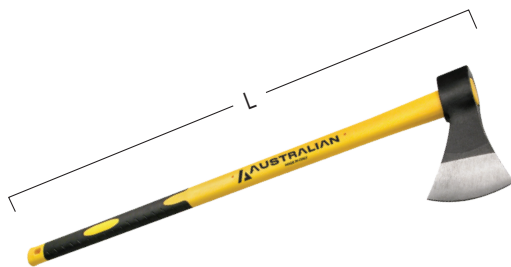

### Ascia con manico anima in fibra di vetro (impugnatura in gomma)

Cutting or splitting axe with glass fibre core handle (rubber haft)  
Hache avec manche trimatière

COD. ART.	Gr.	L mm	BOX	COD. EAN - 13
AA 14091 G	1400	910	6	80 3264633 257 5
AA 14100 G	1400	1000	6	80 3264633 118 9
Mercato / Markets / Marchés				



### Ascia con manico in legno Mix

Cutting or splitting axe with wooden handle Mix  
Hache avec manche en bois Mix

COD. ART.	Gr.	L mm	BOX	COD. EAN - 13
AA 14091 L/MIX	1400	910	6	80 3264633 278 0
Mercato / Markets / Marchés				



### Ascia con manico in frassino verniciato

Cutting or splitting axe with painted ash wood handle  
Hache avec manche en bois de frene verni

COD. ART.	Gr.	L mm	BOX	COD. EAN - 13
AA 14091 LFV	1400	910	6	80 3264633 652 8
Mercato / Markets / Marchés				



### Ascia con manico in legno

Cutting or splitting axe with wooden handle  
Hache avec manche en bois

COD. ART.	Gr.	L mm	BOX	COD. EAN - 13
AA 14091 L	1400	910	6	80 3264633 433 3
Mercato / Markets / Marchés				







### Mazza scure Merlin con manico sagomato anima fibra di vetro (impugnatura in gomma)

Woodsplitting axe with shaped glass fibre core handle (rubber haft)  
Merlin avec manche trimatière

NEW

COD. ART.	Gr.	L mm	BOX	COD. EAN - 13
MSS 2585 G	2500	850	6	80 5773372 205 3
MSS 3085 G	3000	850	6	80 5773372 206 0
MSS 3585 G	3500	850	6	80 5773372 207 7





Mercato / Markets / Marchés    



### Mazza scure Merlin con manico fibra di vetro (impugnatura in gomma)

Woodsplitting axe with glass fibre core handle (rubber haft)  
Merlin avec manche trimatière

COD. ART.	Gr.	L mm	BOX	COD. EAN - 13
MSA 2591 G	2500	910	4	80 3264633 113 4
MSA 25100 G	2500	1000	4	80 3264633 114 1
MSA 3091 G	3000	910	4	80 3264633 349 7
MSA 30100 G	3000	1000	4	80 3264633 350 3
MSA 3591 G	3500	910	4	80 3264633 115 8
MSA 35100 G	3500	1000	4	80 3264633 116 5





Mercato / Markets / Marchés    



### Mazza scure Merlin con manico in frassino verniciato

Woodsplitting axe with painted ash wood handle  
Merlin avec manche en bois de frene verni

COD. ART.	Gr.	L mm	BOX	COD. EAN - 13
MSA 2591 L FV	2500	910	4	80 3264633 653 5
MSA 3091 L FV	3000	910	4	80 3264633 654 2
MSA 3591 L FV	3500	910	4	80 3264633 655 9





Mercato / Markets / Marchés    



### Mazza scure Merlin con manico in legno Mix

Woodsplitting axe with wooden handle Mix  
Merlin avec manche en bois Mix

COD. ART.	Gr.	L mm	BOX	COD. EAN - 13
MSA 2591 L/MIX	2500	910	4	80 3264633 238 4
MSA 3091 L/MIX	3000	910	4	80 3264633 427 2
MSA 3591 L/MIX	3500	910	4	80 3264633 352 7





Mercato / Markets / Marchés    



### Mazza scure Merlin con manico in legno

Woodsplitting axe with wooden handle  
Merlin avec manche en bois

COD. ART.	Gr.	L mm	BOX	COD. EAN - 13
MSA 2591 L	2500	910	4	80 3264633 428 9
MSA 3091 L	3000	910	4	80 3264633 429 6
MSA 3591 L	3500	910	4	80 3264633 430 2

Mercato / Markets / Marchés    

MARTELLERIA 4

MAZZE e  
PICCONI 20

SCALPELLI e  
LEVERINI 24

ARTICOLI PER  
PIETRA 26

SECCHI, CAZZUOLE,  
SPATOLE e VARIE 27

BADILI, PALE,  
RASCHIETTI  
e RASCHIAFANGO 39

ACCETTE, PICOZZINI,  
RONCOLE e MACETE 52

ASCE, MAZZESCURI  
e CUNEI 55

RASTRELLI,  
SARCHIATORI  
e AERATORI 61

SCOPE FOGLIE 69

RACCOLTA FRUTTA  
e TRATTAMENTO 78

NOVITÀ 84

FORCHE  
e VANGHE 90

ZAPPE, ZAPPINI,  
ATTREZZINI  
e FORBICI 94

MANICI FIBRA 101

MANICI MIX  
e LEGNO 115

ASTE  
TELESCOPICHE 123

ESPOSITORI 124

GUANTI 126

SOLLEVAMENTO  
e ANCORAGGIO 140

- 4 MARTELLERIA
- 20 MAZZE e PICCONI
- 24 SCALPELLI e LEVERINI
- 26 ARTICOLI PER PIETRA
- 27 SECCHI, CAZZUOLE, SPATOLE e VARIE
- 39 BADILI, PALE, RASCHIETTI e RASCHIAFANGO
- 52 ACCETTE, PICOZZINI, RONCOLE e MACETE
- 55 **ASCE, MAZZESCURI e CUNEI**
- 61 RASTRELLI, SARCHIATORI e AERATORI
- 69 SCOPE FOGLIE
- 78 RACCOLTA FRUTTA e TRATTAMENTO
- 84 NOVITÀ
- 90 FORCHE e VANGHE
- 94 ZAPPE, ZAPPINI, ATTREZZINI e FORBICI
- 101 MANICI FIBRA
- 115 MANICI MIX e LEGNO
- 123 ASTE TELESCOPICHE
- 124 ESPOSITORI
- 126 GUANTI
- 140 SOLLEVAMENTO e ANCORAGGIO



### Mazza scure tipo tedesco con manico anima in fibra di vetro (impugnatura in gomma)

German wood splitting axe with glass fibre core handle (rubber haft)  
Merlin allemande avec manche trimatière

COD. ART.	Gr.	L mm	BOX	MANICO
MST 3091 G	3000	910	4	80 3264633 821 8
MST 30100 G	3000	1000	4	80 3264633 822 5
Mercato / Markets / Marchés				



### Mazze scure tipo tedesco con manico in legno Mix

German wood splitting axe with Mix wooden handle  
Merlin allemande avec manche en bois Mix

COD. ART.	Gr.	L mm	BOX	MANICO
MST 3091 L/MIX	3000	910	4	80 3264633 823 2
Mercato / Markets / Marchés				



### Mazze scure tipo tedesco con manico in frassino verniciato

German wood splitting axe with painted ash wood handle  
Merlin allemande avec manche en bois de frene verni

COD. ART.	Gr.	L mm	BOX	MANICO
MST 3091 LFV	3000	910	4	80 3264633 656 6
Mercato / Markets / Marchés				



### Mazze scure tipo tedesco con manico in legno

German wood splitting axe with wooden handle  
Merlin allemande avec manche en bois

COD. ART.	Gr.	L mm	BOX	MANICO
MST 3091 L	3000	910	4	80 3264633 824 9
Mercato / Markets / Marchés				



NEW

### Cuneo spaccalegna

Wood splitting wedge  
Coin a bois

COD. ART.	Gr.	BOX	COD. EAN - 13
CS 15	1500	6	80 5773372 351 7
CS 20	2000	6	80 5773372 352 4
CS 30	3000	6	80 5773372 353 1
Mercato / Markets / Marchés			



NEW

### Cuneo spaccalegna elicoidale

Twisted wood splitting wedge  
Coin eclateur a bois

COD. ART.	Gr.	BOX	COD. EAN - 13
CSE 22	2250	6	80 5773372 354 8
Mercato / Markets / Marchés			

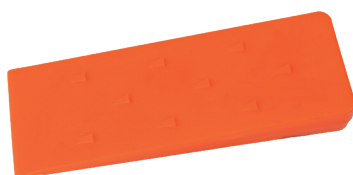

### Cuneo spaccalegna in plastica

Plastic wood splitting wedge  
Coin a bois en plastique

COD. ART.	L mm	Gr.	BOX	COD. EAN - 13
CSPA 14	140	210	6	80 5773372 742 3
CSPA 20	200	300	6	80 5773372 743 0
Mercato / Markets / Marchés				



### Ascia senza manico

Cutting or splitting axe without handle  
Hache sans manche

COD. ART.	Gr.	BOX	COD. EAN - 13
AA 140	1400	6	80 3264633 434 0
Mercato / Markets / Marchés			

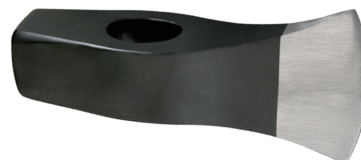

### Mazza scure Merlin senza manico

Woodsplitting axe without handle  
Merlin sans manche

COD. ART.	Gr.	BOX	COD. EAN - 13
MSA 25 E	2500	4	80 3264633 431 9
MSA 30 E	3000	4	80 3264633 506 4
MSA 35 E	3500	4	80 3264633 432 6
Mercato / Markets / Marchés			



### Mazze scure tipo tedesco senza manico

German wood splitting axe without handle  
Merlin allemande sans manche

COD. ART.	Gr.	BOX	COD. EAN - 13
MST 30	3000	4	80 3264633 825 6
Mercato / Markets / Marchés			



### Accetta senza manico

Hatchet without handle  
Hachette sans manche

COD. ART.	Gr.	BOX	COD. EAN - 13
AP 06	600	6	80 3264633 435 7
Mercato / Markets / Marchés			

MARTELLERIA 4

MAZZE e  
PICCONI 20

SCALPELLI e  
LEVERINI 24

ARTICOLI PER  
PIETRA 26

SECCHI, CAZZUOLE,  
SPATOLE e VARIE 27

BADILI, PALE,  
RASCHIETTI  
e RASCHIAFANGO 39

ACCETTE, PICOZZINI,  
RONCOLE e MACETE 52

ASCE, MAZZESCURI  
e CUNEI 55

RASTRELLI,  
SARCHIATORI  
e AERATORI 61

SCOPE FOGLIE 69

RACCOLTA FRUTTA  
e TRATTAMENTO 78

NOVITÀ 84

FORCHE  
e VANGHE 90

ZAPPE, ZAPPINI,  
ATTREZZINI  
e FORBICI 94

MANICI FIBRA 101

MANICI MIX  
e LEGNO 115

ASTE  
TELESCOPICHE 123

ESPOSITORI 124

GUANTI 126

SOLLEVAMENTO  
e ANCORAGGIO 140

4 MARTELLERIA  
 17 MAZZE e PICCONI  
 24 SCALPELLI e LEVERINI  
 26 ARTICOLI PER PIETRA  
 30 SECCHI, CAZZUOLE, SPATOLE e VARIE  
 39 BADILI, PALE, RASCHIETTI e RASCHIAFANGO  
 51 ACCETTE, PICOZZINI, RONCOLE e MACETE  
 54 ASCE, MAZZESCURI e CUNEI  
 60 RASTRELLI, SARCHIATORI e AERATORI  
 68 SCOPE FOGLIE  
 78 RACCOLTA FRUTTA e TRATTAMENTO  
 83 NOVITÀ  
 88 FORCHE e VANGHE  
 92 ZAPPE, ZAPPINI, ATTREZZINI e FORBICI  
 98 MANICI FIBRA  
 112 MANICI MIX e LEGNO  
 120 ASTE TELESCOPICHE  
 121 ESPOSITORI  
 123 GUANTI  
 138 SOLLEVAMENTO e ANCORAGGIO





**1 Rastrello 18 denti per fieno in polipropilene con manico ultraleggero in fibra di vetro**

Polypropylene hay rake 18 teeth with ultralight fibreglass handle  
Râteau en polypropylène pour foin 18 dents avec manche fibre de verre creux super léger

COD. ART.	DENTI	L mm	A mm	BOX	COD. EAN - 13
120 RD18 P	18	1200	570	6	80 3264633 838 6
150 RD18 P	18	1500	570	6	80 3264633 839 3
180 RD18 P	18	1800	570	6	80 3264633 840 9

Mercato / Markets / Marchés

**2 Rastrello 18 denti per fieno in polipropilene con manico in legno**

Polypropylene hay rake 18 teeth with wooden handle  
Râteau en polypropylène pour foin 18 dents avec manche en bois

COD. ART.	DENTI	L mm	A mm	BOX	COD. EAN - 13
150 RD18 LE	18	1500	570	6	80 3264633 841 6
180 RD18 LE	18	1800	570	6	80 3264633 842 3

Mercato / Markets / Marchés

**3 Rastrello 18 denti per fieno in polipropilene**

Polypropylene hay rake 18 teeth  
Râteau en polypropylène pour foin 18 dents

COD. ART.	DENTI	A mm	BOX	COD. EAN - 13
RD18	18	570	12	80 3264633 843 0

Mercato / Markets / Marchés

**4 Rastrello polipropilene 22 denti curvi**

Polypropylene rake 22 curved teeth  
Râteau en polypropylène 20 dents courbées

COD. ART.	DENTI	A mm	BOX	COD. EAN - 13
RDC22	22	580	12	80 3264633 837 9

Mercato / Markets / Marchés

**5 Rastrello polipropilene 22 denti curvi con manico ultraleggero in fibra di vetro**

Polypropylene rake 22 curved teeth with ultralight fibreglass handle  
Râteau en polypropylène 22 dents courbées avec manche fibre de verre creux super léger

COD. ART.	DENTI	L mm	A mm	BOX	COD. EAN - 13
120RDC22P	22	1200	580	6	80 3264633 832 4
150RDC22P	22	1500	580	6	80 3264633 833 1
180RDC22P	22	1800	580	6	80 3264633 834 8

Mercato / Markets / Marchés

**6 Rastrello polipropilene 22 denti curvi con manico in legno**

Polypropylene rake 22 curved teeth with wooden handle  
Râteau en polypropylène 22 dents courbées avec manche en bois

COD. ART.	DENTI	L mm	A mm	BOX	COD. EAN - 13
150RDC22LE	22	1500	580	6	80 3264633 835 5
180RDC22LE	22	1800	580	6	80 3264633 836 2

Mercato / Markets / Marchés

MARTELLERIA	4
MAZZE e PICCONI	20
SCALPELLI e LEVERINI	24
ARTICOLI PER PIETRA	26
SECCHI, CAZZUOLE, SPATOLE e VARIE	27
BADILI, PALE, RASCHIETTI e RASCHIAFANGO	39
ACCETTE, PICOZZINI, RONCOLE e MACETE	52
ASCE, MAZZESCURI e CUNEI	55
<b>RASTRELLI, SARCHIATORI e AERATORI</b>	<b>61</b>
SCOPE FOGLIE	69
RACCOLTA FRUTTA e TRATTAMENTO	78
NOVITÀ	84
FORCHE e VANGHE	90
ZAPPE, ZAPPINI, ATTREZZINI e FORBICI	94
MANICI FIBRA	101
MANICI MIX e LEGNO	115
ASTE TELESCOPICHE	123
ESPOSITORI	124
GUANTI	126
SOLLEVAMENTO e ANCORAGGIO	140

- 4 MARTELLERIA
- 20 MAZZE e PICCONI
- 24 SCALPELLI e LEVERINI
- 26 ARTICOLI PER PIETRA
- 27 SECCHI, CAZZUOLE, SPATOLE e VARIE
- 39 BADILI, PALE, RASCHIETTI e RASCHIAFANGO
- 52 ACCETTE, PICOZZINI, RONCOLE e MACETE
- 55 ASCE, MAZZESCURI e CUNEI
- 61 **RASTRELLI, SARCHIATORI e AERATORI**
- 69 SCOPE FOGLIE
- 78 RACCOLTA FRUTTA e TRATTAMENTO
- 84 NOVITÀ
- 90 FORCHE e VANGHE
- 94 ZAPPE, ZAPPINI, ATTREZZINI e FORBICI
- 101 MANICI FIBRA
- 115 MANICI MIX e LEGNO
- 123 ASTE TELESCOPICHE
- 124 ESPOSITORI
- 126 GUANTI
- 140 SOLLEVAMENTO e ANCORAGGIO



**7 Rastrello curvo in polipropilene tipo "Aosta" 18 denti con manico ultraleggero in fibra di vetro**

Polypropylene curved rake 18 teeth with ultralight fibreglass handle  
Râteau courbé en polyprop. 18 dents avec manche creux superléger

COD. ART.	DENTI	L mm	A mm	BOX	COD. EAN - 13
120 RC18 P	18	1200	570	6	80 3264633 826 3
150 RC18 P	18	1500	570	6	80 3264633 827 0
180 RC18 P	18	1800	570	6	80 3264633 828 7

Mercato / Markets / Marchés

**9 Rastrello curvo in polipropilene tipo "Aosta" 18 denti**

Polypropylene curved rake 18 teeth  
Râteau courbé en polypropylène 18 dents

COD. ART.	DENTI	A mm	BOX	COD. EAN - 13
RC18	18	570	12	80 3264633 831 7

Mercato / Markets / Marchés

**8 Rastrello curvo in polipropilene tipo "Aosta" 18 denti con manico in legno**

Polypropylene curved rake 18 teeth with wooden handle  
Râteau courbé en polypropylène 18 dents avec manche en bois

COD. ART.	DENTI	L mm	A mm	BOX	COD. EAN - 13
150 RC18 LE	18	1500	570	6	80 3264633 829 4
180 RC18 LE	18	1800	570	6	80 3264633 830 0

Mercato / Markets / Marchés



**1 Rastrello in ferro 20 denti con manico ultraleggero in fibra di vetro**

Iron rake 20 teeth with ultralight fibreglass handle  
Râteau en fer 20 dents avec manche fibre de verre creux super léger

COD. ART.	DENTI	L mm	A mm	BOX	COD. EAN - 13
150 R20F P	20	1500	600	6	80 3264633 657 3
180 R20F P	20	1800	600	6	80 3264633 658 0

Mercato / Markets / Marchés



**2 Rastrello in ferro 20 denti con manico in legno**

Iron rake 20 teeth with wooden handle  
Râteau en fer 20 dents avec manche en bois

COD. ART.	DENTI	L mm	A mm	BOX	COD. EAN - 13
150 R20F LE	20	1500	600	6	80 3264633 659 7
180 R20F LE	20	1800	600	6	80 3264633 660 3

Mercato / Markets / Marchés



**3 Rastrello in ferro 20 denti**

Iron rake 20 teeth  
Râteau en fer 20 dents

COD. ART.	DENTI	L mm	A mm	BOX	COD. EAN - 13
R20F	20	600	6		80 3264633 625 2

Mercato / Markets / Marchés



**4 Rastrello in ferro 34 denti per tappeto erboso**

Iron lawn rake 34 teeth  
Râteau à gazon en fer 34 dents

COD. ART.	DENTI	L mm	A mm	BOX	COD. EAN - 13
RTE34	34	600	6		80 3264633 626 9

Mercato / Markets / Marchés



**5 Rastrello in ferro 34 denti per tappeto erboso con manico ultraleggero in fibra di vetro**

Iron lawn rake 34 teeth with ultralight fibreglass handle  
Râteau à gazon en fer 34 dents avec manche fibre de verre creux super léger

COD. ART.	DENTI	L mm	A mm	BOX	COD. EAN - 13
150 RTE34 P	20	1500	600	6	80 3264633 663 4
180 RTE34 P	20	1800	600	6	80 3264633 664 1

Mercato / Markets / Marchés



**6 Rastrello in ferro 34 denti per tappeto erboso con manico in legno**

Iron lawn rake 34 teeth with wooden handle  
Râteau à gazon en fer 34 dents avec manche en bois

COD. ART.	DENTI	L mm	A mm	BOX	COD. EAN - 13
150 RTE34 LE	20	1500	600	6	80 3264633 665 8
180 RTE34 LE	20	1800	600	6	80 3264633 666 5

Mercato / Markets / Marchés



MARTELLERIA	4
MAZZE e PICCONI	20
SCALPELLI e LEVERINI	24
ARTICOLI PER PIETRA	26
SECCHI, CAZZUOLE, SPATOLE e VARIE	27
BADILI, PALE, RASCHIETTI e RASCHIAFANGO	39
ACCETTE, PICOZZINI, RONCOLE e MACETE	52
ASCE, MAZZESCURI e CUNEI	55
<b>RASTRELLI, SARCHIATORI e AERATORI</b>	<b>61</b>
SCOPE FOGLIE	69
RACCOLTA FRUTTA e TRATTAMENTO	78
NOVITÀ	84
FORCHE e VANGHE	90
ZAPPE, ZAPPINI, ATTREZZINI e FORBICI	94
MANICI FIBRA	101
MANICI MIX e LEGNO	115
ASTE TELESCOPICHE	123
ESPOSITORI	124
GUANTI	126
SOLLEVAMENTO e ANCORAGGIO	140

4 MARTELLERIA

20 MAZZE e PICCONI

24 SCALPELLI e LEVERINI

26 ARTICOLI PER PIETRA

27 SECCHI, CAZZUOLE, SPATOLE e VARIE

39 BADILI, PALE, RASCHIETTI e RASCHIAFANGO

52 ACCETTE, PICOZZINI, RONCOLE e MACETE

55 ASCE, MAZZESCURI e CUNEI

**61 RASTRELLI, SARCHIATORI e AERATORI**

69 SCOPE FOGLIE

78 RACCOLTA FRUTTA e TRATTAMENTO

84 NOVITÀ

90 FORCHE e VANGHE

94 ZAPPE, ZAPPINI, ATTREZZINI e FORBICI

101 MANICI FIBRA

115 MANICI MIX e LEGNO

123 ASTE TELESCOPICHE

124 ESPOSITORI

126 GUANTI

140 SOLLEVAMENTO e ANCORAGGIO







**NEW**

**Rastrello in ferro zincato con rinforzo con manico ultraleggero in fibra di vetro**

Galvanized reinforced iron rake with ultralight fiberglass handle  
Râteau en fer renforcé galvanisé avec manche fibre de verre

COD. ART.	DENTI	L mm	A mm	BOX	COD. EAN - 13
150 RF14 PR	14	1500	350	6	80 5773372 269 5
150 RF16 PR	16	1500	350	6	80 5773372 270 1

Mercato / Markets / Marchés  





**NEW**

**Rastrello in ferro zincato con rinforzo con manico in legno**

Galvanized reinforced iron rake with wooden handle  
Râteau en fer renforcé galvanisé avec manche en bois

COD. ART.	DENTI	L mm	A mm	BOX	COD. EAN - 13
150 RRF14 LE	14	1500	350	6	80 5773372 283 1
150 RRF16 LE	16	1500	350	6	80 5773372 242 8

Mercato / Markets / Marchés  





**NEW**

**Rastrello in ferro zincato con rinforzo**

Galvanized reinforced iron rake  
Râteau en fer renforcé galvanisé

COD. ART.	DENTI	A mm	BOX	COD. EAN - 13
RF14R	14	350	6	80 5773372 235 0
RF16R	16	350	6	80 5773372 236 7

Mercato / Markets / Marchés  

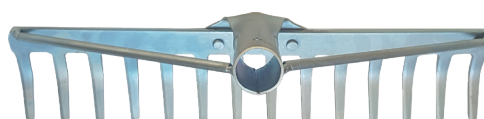

MARTELLERIA	4
MAZZE e PICCONI	20
SCALPELLI e LEVERINI	24
ARTICOLI PER PIETRA	26
SECCHI, CAZZUOLE, SPATOLE e VARIE	27
BADILI, PALE, RASCHIETTI e RASCHIAFANGO	39
ACCETTE, PICOZZINI, RONCOLE e MACETE	52
ASCE, MAZZESCURI e CUNEI	55
<b>RASTRELLI, SARCHIATORI e AERATORI</b>	<b>61</b>
SCOPE FOGLIE	69
RACCOLTA FRUTTA e TRATTAMENTO	78
NOVITÀ	84
FORCHE e VANGHE	90
ZAPPE, ZAPPINI, ATTREZZINI e FORBICI	94
MANICI FIBRA	101
MANICI MIX e LEGNO	115
ASTE TELESCOPICHE	123
ESPOSITORI	124
GUANTI	126
SOLLEVAMENTO e ANCORAGGIO	140

4	MARTELLERIA
20	MAZZE e PICCONI
24	SCALPELLI e LEVERINI
26	ARTICOLI PER PIETRA
27	SECCHI, CAZZUOLE, SPATOLE e VARIE
39	BADILI, PALE, RASCHIETTI e RASCHIAFANGO
52	ACCETTE, PICOZZINI, RONCOLE e MACETE
55	ASCE, MAZZESCURI e CUNEI
61	<b>RASTRELLI, SARCHIATORI e AERATORI</b>
69	SCOPE FOGLIE
78	RACCOLTA FRUTTA e TRATTAMENTO
84	NOVITÀ
90	FORCHE e VANGHE
94	ZAPPE, ZAPPINI, ATTREZZINI e FORBICI
101	MANICI FIBRA
115	MANICI MIX e LEGNO
123	ASTE TELESCOPICHE
124	ESPOSITORI
126	GUANTI
140	SOLLEVAMENTO e ANCORAGGIO

### Rastrello in ferro con manico ultraleggero in fibra di vetro

Iron rake with ultralight fibreglass handle  
Râteau en fer avec manche fibre de verre creux super léger

COD. ART.	DENTI	L mm	A mm	BOX	COD. EAN - 13
150 RF10 P	10	1500	250	6	80 5773372 000 4
150 RF12 P	12	1500	300	6	80 5773372 001 1
150 RF14 P	14	1500	400	6	80 3264633 850 8
150 RF16 P	16	1500	430	6	80 3264633 851 5
150 RF18 P	18	1500	460	6	80 3264633 852 2

Mercato / Markets / Marchés



### Rastrello in ferro con manico in legno

Iron rake with wooden handle  
Râteau en fer avec manche en bois

COD. ART.	DENTI	L mm	A mm	BOX	COD. EAN - 13
150 RF10 LE	10	1500	250	6	80 5773372 002 8
150 RF12 LE	12	1500	300	6	80 5773372 003 5
150 RF14 LE	14	1500	400	6	80 3264633 853 9
150 RF16 LE	16	1500	430	6	80 3264633 854 6
150 RF18 LE	18	1500	460	6	80 3264633 855 3

Mercato / Markets / Marchés



### Rastrello in ferro

Iron rake  
Râteau en fer

COD. ART.	DENTI	A mm	BOX	COD. EAN - 13
RF10	10	250	6	80 3264633 616 0
RF12	12	300	6	80 3264633 617 7
RF14	14	400	6	80 3264633 346 6
RF16	16	430	6	80 3264633 347 3
RF18	18	460	6	80 3264633 491 3

Mercato / Markets / Marchés



**Rastrello sarchiatore in ferro con manico ultraleggero in fibra di vetro**

Iron weeding rake with ultralight fibreglass handle  
Râteau sarclage en fer avec manche fibre de verre creux superléger

COD. ART.	DENTI	L mm	A mm	BOX	COD. EAN - 13
150 RS14 P	14	1500	370	6	80 5773372 004 2
150 RS16 P	16	1500	425	6	80 5773372 005 9
Mercato / Markets / Marchés					



**Rastrello sarchiatore in ferro con manico in legno**

Iron weeding rake with wooden handle  
Râteau sarclage en fer avec manche en bois

COD. ART.	DENTI	L mm	A mm	BOX	COD. EAN - 13
150 RS14 LE	14	1500	370	6	80 5773372 006 6
150 RS16 LE	16	1500	425	6	80 5773372 007 3
Mercato / Markets / Marchés					



**Rastrello sarchiatore in ferro**

Iron weeding rake  
Râteau sarclage en fer

COD. ART.	DENTI	A mm	BOX	COD. EAN - 13
RS14	14	370	6	80 3264633 619 1
RS16	16	425	6	80 3264633 620 7
Mercato / Markets / Marchés				



MARTELLERIA	4
MAZZE e PICCONI	20
SCALPELLI e LEVERINI	24
ARTICOLI PER PIETRA	26
SECCHI, CAZZUOLE, SPATOLE e VARIE	27
BADILI, PALE, RASCHIETTI e RASCHIAFANGO	39
TESTATE, PICOZZINI, MANICOLE e MACETE	52
ASCE, MAZZESCURI e CUNEI	55
<b>RASTRELLI, SARCHIATORI e AERATORI</b>	<b>61</b>
SCOPE FOGLIE	69
RACCOLTA FRUTTA e TRATTAMENTO	78
NOVITÀ	84
FORCHE e VANGHE	90
ZAPPE, ZAPPINI, ATTREZZINI e FORBICI	94
MANICI FIBRA	101
MANICI MIX e LEGNO	115
ASTE TELESCOPICHE	123
ESPOSITORI	124
GUANTI	126
SOLLEVAMENTO e ANCORAGGIO	140

4	MARTELLERIA
20	MAZZE e PICCONI
24	SCALPELLI e LEVERINI
26	ARTICOLI PER PIETRA
27	SECCHI, CAZZUOLE, SPATOLE e VARIE
39	BADILI, PALE, RASCHIETTI e RASCHIAFANGO
52	ACCETTE, PICOZZINI, RONCOLE e MACETE
55	ASCE, MAZZESCURI e CUNEI
61	<b>RASTRELLI, SARCHIATORI e AERATORI</b>
69	SCOPE FOGLIE
78	RACCOLTA FRUTTA e TRATTAMENTO
84	NOVITÀ
90	FORCHE e VANGHE
94	ZAPPE, ZAPPINI, ATTREZZINI e FORBICI
101	MANICI FIBRA
115	MANICI MIX e LEGNO
123	ASTE TELESCOPICHE
124	ESPOSITORI
126	GUANTI
140	SOLLEVAMENTO e ANCORAGGIO

### Rastrello aeratore doppio 32 denti con manico ultraleggero fibra di vetro

Iron aerator rake 32 teeth with ultralight fibreglass handle  
Râteau aérateur en fer 32 dents avec manche fibre de verre creux super léger

COD. ART.	DENTI	L mm	A mm	BOX	COD. EAN - 13
150 RA32 P	32	1500	370	6	80 5773372 008 0

Mercato / Markets / Marchés



### Rastrello aeratore doppio 32 denti con manico in legno

Iron aerator rake 32 teeth with wooden handle  
Râteau aérateur en fer 32 dents avec manche en bois

COD. ART.	DENTI	L mm	A mm	BOX	COD. EAN - 13
150 RA32 LE	32	1500	370	6	80 5773372 009 7

Mercato / Markets / Marchés



### Rastrello aeratore doppio in ferro 32 denti

Iron aerator rake 32 teeth  
Râteau aérateur en fer 32 dents

COD. ART.	DENTI	A mm	BOX	COD. EAN - 13
RA32	32	370	6	80 3264633 621 4

Mercato / Markets / Marchés



### Scopa sintetica a fili con manico in fibra di vetro ultraleggero

Wire synthetic broom with ultralight fiber handle  
Balai synthétique italienne avec manche ultraleger en fibre de verre

COD. ART.	L mm	A mm	B mm	Gr.	BOX	COD. EAN - 13
150 SS P	1500	150	500	1035	6	80 3264633 955 0
180 SS P	1800	150	500	1100	6	80 3264633 956 7

Mercato / Markets / Marchés 



### Scopa sintetica a fili con manico in legno

Wire synthetic broom with wooden handle  
Balai synthétique italienne avec manche en bois

COD. ART.	L mm	A mm	B mm	Gr.	BOX	COD. EAN - 13
150 SS LE	1500	150	500	1100	6	80 3264633 957 4
180 SS LE	1800	150	500	1200	6	80 3264633 958 1

Mercato / Markets / Marchés 



### Scopa sintetica a fili

Wire synthetic broom  
Balai synthétique italienne

COD. ART.	Gr.	A mm	B mm	BOX	COD. EAN - 13
SS	560	150	500	12	80 3264633 269 8

Mercato / Markets / Marchés 



MARTELLERIA	4
MAZZE e PICCONI	20
SCALPELLI e LEVERINI	24
ARTICOLI PER PIETRA	26
SECCHI, CAZZUOLE, SPATOLE e VARIE	27
BADILI, PALE, RASCHIETTI e RASCHIAFANGO	39
ACCETTE, PICOZZINI, RONCOLE e MACETE	52
ASCE, MAZZESCURI e CUNEI	55
RASTRELLI, SARCHIATORI e AERATORI	61
<b>SCOPE FOGLIE</b>	<b>69</b>
RACCOLTA FRUTTA e TRATTAMENTO	78
NOVITÀ	84
FORCHE e VANGHE	90
ZAPPE, ZAPPINI, ATTREZZINI e FORBICI	94
MANICI FIBRA	101
MANICI MIX e LEGNO	115
ASTE TELESCOPICHE	123
ESPOSITORI	124
GUANTI	126
SOLLEVAMENTO e ANCORAGGIO	140

- 4 MARTELLERIA
- 20 MAZZE e PICCONI
- 24 SCALPELLI e LEVERINI
- 26 ARTICOLI PER PIETRA
- 27 SECCHI, CAZZUOLE, SPATOLE e VARIE
- 39 BADILI, PALE, RASCHIETTI e RASCHIAFANGO
- 52 ACCETTE, PICOZZINI, RONCOLE e MACETE
- 55 ASCE, MAZZESCURI e CUNEI
- 61 RASTRELLI, SARCHIATORI e AERATORI
- 69 SCOPE FOGLIE**
- 78 RACCOLTA FRUTTA e TRATTAMENTO
- 84 NOVITÀ
- 90 FORCHE e VANGHE
- 94 ZAPPE, ZAPPINI, ATTREZZINI e FORBICI
- 101 MANICI FIBRA
- 115 MANICI MIX e LEGNO
- 123 ASTE TELESCOPICHE
- 124 ESPOSITORI
- 126 GUANTI
- 140 SOLLEVAMENTO e ANCORAGGIO

### Scopa per foglie / olive polipropilene rinforzata con manico ultraleggero in fibra di vetro

Polypropylene reinforced broom for leaves and olives with ultralight fibreglass handle  
Balai en polypropylène renforcé pour feuilles et olives avec manche creux super léger

COD. ART.	DENTI	L mm	A mm	BOX	COD. EAN - 13
120 SF20 P	20	1200	450	6	80 3264633 817 1
150 SF20 P	20	1500	450	6	80 3264633 856 0
180 SF20 P	20	1800	450	6	80 3264633 857 7

Mercato / Markets / Marchés  

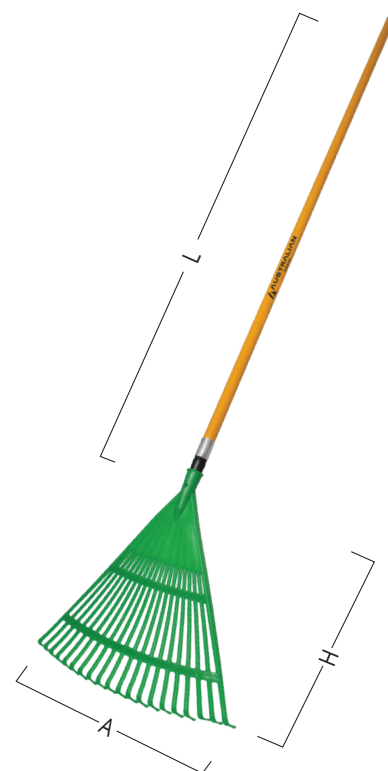

### Scopa per foglie / olive polipropilene rinforzata con manico in legno

Polypropylene reinforced broom for leaves and olives with wooden handle  
Balai en polypropylène renforcé pour feuilles et olives avec manche en bois

COD. ART.	DENTI	L mm	A mm	BOX	COD. EAN - 13
150 SF20 LE	20	1500	450	6	80 3264633 858 4
180 SF20 LE	20	1800	450	6	80 3264633 859 1

Mercato / Markets / Marchés  



### Scopa per foglie / olive polipropilene rinforzata

Polypropylene reinforced broom for leaves and olives  
Balai en polypropylène renforcé pour feuilles et olives

COD. ART.	DENTI	A mm	H mm	BOX	COD. EAN - 13
SF20	20	450	400	12	80 3264633 860 7

Mercato / Markets / Marchés  

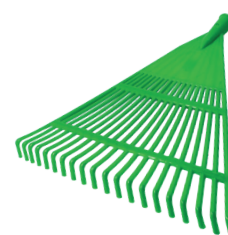

**AUSTRALIAN**

**NOVITÀ**

# SCOPE FOGLIE

## PLUS



**DESIGN INNOVATIVI**

*Modern design  
Design moderne*

**MATERIALE AD ALTA  
RESISTENZA E FLESSIBILITÀ**

*High resistance and flexibility material  
Material haute résistance et flexibilité*

**SUPER LEGGERE**

*Ultralight  
Super légère*

**SUPER FLESSIBILI**

*Super flexible  
Balai flexible*



## EXTRA

Queste scope di grandi dimensioni sono perfette per la pulizia di cortili e giardini, anche di grandi dimensioni. Permettono di risparmiare tempo e rendere più facile e veloce il lavoro.

*These large brooms are perfect for cleaning courtyards and gardens, even large ones.  
They save time and make work easier and faster.*

*Ces grands balais sont parfaits pour nettoyer les cours et les jardins, même les plus grands.  
Ils font gagner du temps et facilitent et accélèrent le travail.*

  
**MADE IN ITALY**

**[www.australiantools.it](http://www.australiantools.it)**

- 4 MARTELLERIA
- 20 MAZZE e PICCONI
- 24 SCALPELLI e LEVERINI
- 26 ARTICOLI PER PIETRA
- 27 SECCHI, CAZZUOLE, SPATOLE e VARIE
- 39 BADILI, PALE, RASCHIETTI e RASCHIAFANGO
- 52 ACCETTE, PICOZZINI, RONCOLE e MACETE
- 55 ASCE, MAZZESCURI e CUNEI
- 61 RASTRELLI, SARCHIATORI e AERATORI
- 69 SCOPE FOGLIE**
- 78 RACCOLTA FRUTTA e TRATTAMENTO
- 84 NOVITÀ
- 90 FORCHE e VANGHE
- 94 ZAPPE, ZAPPINI, ATTREZZINI e FORBICI
- 101 MANICI FIBRA
- 115 MANICI MIX e LEGNO
- 123 ASTE TELESCOPICHE
- 124 ESPOSITORI
- 126 GUANTI
- 140 SOLLEVAMENTO e ANCORAGGIO





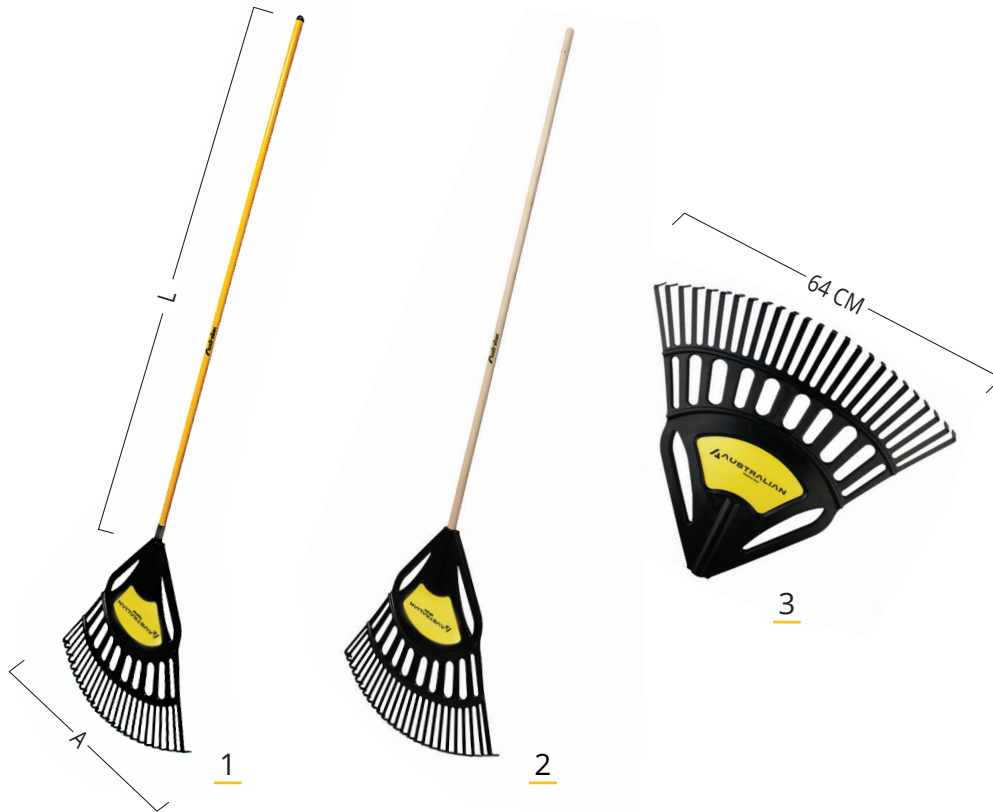

**1 Scopa per foglie Extra in polipropilene con manico in fibra di vetro ultraleggero**

Polyprop. Extra broom for leaves with ultralight fibreglass handle  
Balai Extra en polyprop. pour feuilles avec manche ultraleger en fibre de verre

COD. ART.	DENTI	L mm	A mm	BOX	COD. EAN - 13
150 SFE25 P	25	1500	640	6	80 5773372 016 5

Mercato / Markets / Marchés



**3 Scopa per foglie Extra in polipropilene**

Polypropylene Extra broom for leaves  
Balai Extra en polypropylène pour feuilles

COD. ART.	DENTI	A mm	BOX	COD. EAN - 13
SFE25	25	640	25	80 5773372 018 9

Mercato / Markets / Marchés



**2 Scopa per foglie Extra in polipropilene con manico in legno**

Polyprop. Extra broom for leaves with wooden handle  
Balai Extra en polyprop. pour feuilles avec manche en bois

COD. ART.	DENTI	L mm	A mm	BOX	COD. EAN - 13
150 SFE25 LE	25	1500	640	6	80 5773372 017 2

Mercato / Markets / Marchés



MARTELLERIA	4
MAZZE e PICCONI	20
SCALPELLI e LEVERINI	24
ARTICOLI PER PIETRA	26
SECCHI, CAZZUOLE, SPATOLE e VARIE	27
BADILI, PALE, RASCHIETTI e RASCHIAFANGO	39
ACCETTE, PICOZZINI, RONCOLE e MACETE	52
ASCE, MAZZESCURI e CUNEI	55
RASTRELLI, SARCHIATORI e AERATORI	61
<b>SCOPE FOGLIE</b>	<b>69</b>
RACCOLTA FRUTTA e TRATTAMENTO	78
NOVITÀ	84
FORCHE e VANGHE	90
ZAPPE, ZAPPINI, ATTREZZINI e FORBICI	94
MANICI FIBRA	101
MANICI MIX e LEGNO	115
ASTE TELESCOPICHE	123
ESPOSITORI	124
GUANTI	126
SOLLEVAMENTO e ANCORAGGIO	140

- 4 MARTELLERIA
- 20 MAZZE e PICCONI
- 24 SCALPELLI e LEVERINI
- 26 ARTICOLI PER PIETRA
- 27 SECCHI, CAZZUOLE, SPATOLE e VARIE
- 39 BADILI, PALE, RASCHIETTI e RASCHIAFANGO
- 52 ACCETTE, PICOZZINI, RONCOLE e MACETE
- 55 ASCE, MAZZESCURI e CUNEI
- 61 RASTRELLI, SARCHIATORI e AERATORI
- 69 **SCOPE FOGLIE**
- 78 RACCOLTA FRUTTA e TRATTAMENTO
- 84 NOVITÀ
- 90 FORCHE e VANGHE
- 94 ZAPPE, ZAPPINI, ATTREZZINI e FORBICI
- 101 MANICI FIBRA
- 115 MANICI MIX e LEGNO
- 123 ASTE TELESCOPICHE
- 124 ESPOSITORI
- 126 GUANTI
- 140 SOLLEVAMENTO e ANCORAGGIO



**1** **Scopa per foglie Plus in polipropilene con manico in fibra di vetro ultraleggero**  
 Polyprop. Plus broom for leaves with ultralight fibreglass handle  
 Balai Plus en polyprop. pour feuilles avec manche ultraleger en fibre de verre

COD. ART.	DENTI	L mm	A mm	BOX	COD. EAN - 13
150 PLUS P	27	1500	670	6	80 5773372 237 4

Mercato / Markets / Marchés

**3** **Scopa per foglie Plus in polipropilene**  
 Polypropylene Plus broom for leaves  
 Balai Plus en polypropylène pour feuilles

COD. ART.	DENTI	A mm	BOX	COD. EAN - 13
SPLUS	27	670	25	80 5773372 239 8

Mercato / Markets / Marchés

**2** **Scopa per foglie Plus in polipropilene con manico in legno**  
 Polyprop. Plus broom for leaves with wooden handle  
 Balai Plus en polyprop. pour feuilles avec manche en bois

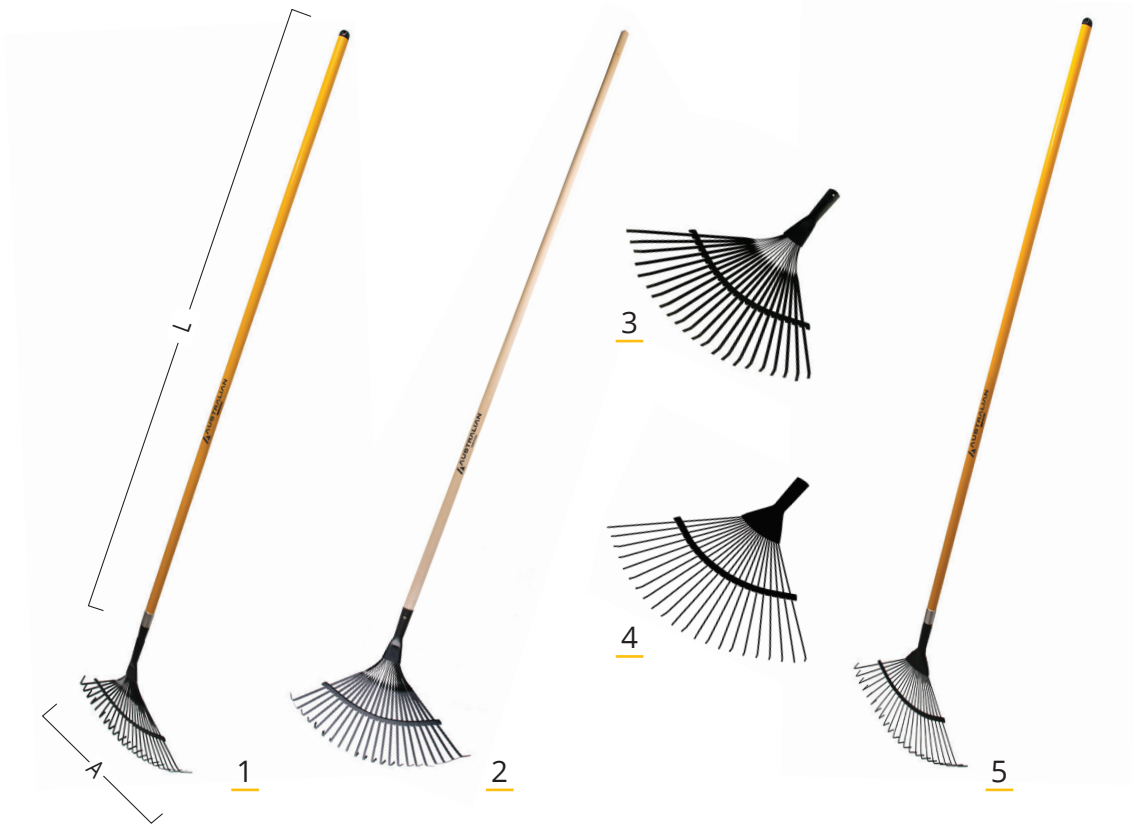

COD. ART.	DENTI	L mm	A mm	BOX	COD. EAN - 13
150 PLUS LE	7	1500	670	6	80 5773372 238 1

Mercato / Markets / Marchés





1 | **Scopa per foglie in ferro denti piatti con manico ultraleggero in fibra di vetro**

Iron broom for leaves flat teeth with ultralight fibreglass handle  
Balai à feuilles en fer dents plates avec manche creux super léger

COD. ART.	DENTI	L mm	A mm	BOX	COD. EAN - 13
150 SFT P	22	1500	450	6	80 5773372 010 3
Mercato / Markets / Marchés  					



2 | **Scopa per foglie in ferro denti piatti con manico in legno**

Iron broom for leaves flat teeth with wooden handle  
Balai à feuilles en fer dents plates avec manche en bois

COD. ART.	DENTI	L mm	A mm	BOX	COD. EAN - 13
150 SFT LE	22	1500	450	6	80 5773372 011 0
Mercato / Markets / Marchés  					



3 | **Scopa per foglie in ferro denti piatti**

Iron broom for leaves flat teeth  
Balai à feuilles en fer dents plates

COD. ART.	DENTI	A mm	BOX	COD. EAN - 13
SFT	22	450	6	80 3264633 624 5
Mercato / Markets / Marchés  				



4 | **Scopa per foglie in ferro denti tondi**

Iron broom for leaves round teeth  
Balai à feuilles en fer dents rondes

COD. ART.	DENTI	A mm	BOX	COD. EAN - 13
SF22F	22	470	6	80 3264633 623 8
Mercato / Markets / Marchés  				

5 | **Scopa per foglie in ferro denti tondi con manico ultraleggero in fibra di vetro**

Iron broom for leaves round teeth with ultralight fibreglass handle  
Balai à feuilles en fer dents rondes avec manche creux super léger

COD. ART.	DENTI	L mm	A mm	BOX	COD. EAN - 13
150 SF22F P	22	1500	470	6	80 5773372 012 7
Mercato / Markets / Marchés  					



MARTELLERIA	4
MAZZE e PICCONI	20
SCALPELLI e LEVERINI	24
ARTICOLI PER PIETRA	26
SECCHI, CAZZUOLE, SPATOLE e VARIE	27
BADILI, PALE, RASCHIETTI e RASCHIAFANGO	39
ACCETTE, PICOZZINI, RONCOLE e MACETE	52
ASCE, MAZZESCURI e CUNEI	55
RASTRELLI, SARCHIATORI e AERATORI	61
<b>SCOPE FOGLIE</b>	<b>69</b>
RACCOLTA FRUTTA e TRATTAMENTO	78
NOVITÀ	84
FORCHE e VANGHE	90
ZAPPE, ZAPPINI, ATTREZZINI e FORBICI	94
MANICI FIBRA	101
MANICI MIX e LEGNO	115
ASTE TELESCOPICHE	123
ESPOSITORI	124
GUANTI	126
SOLLEVAMENTO e ANCORAGGIO	140

4 MARTELLERIA  
 20 MAZZE e PICCONI  
 24 SCALPELLI e LEVERINI  
 26 ARTICOLI PER PIETRA  
 27 SECCHI, CAZZUOLE, SPATOLE e VARIE  
 39 BADILI, PALE, RASCHIETTI e RASCHIAFANGO  
 52 ACCETTE, PICOZZINI, RONCOLE e MACETE  
 55 ASCE, MAZZESCURI e CUNEI  
 61 RASTRELLI, SARCHIATORI e AERATORI  
 69 **SCOPE FOGLIE**  
 78 RACCOLTA FRUTTA e TRATTAMENTO  
 84 NOVITÀ  
 90 FORCHE e VANGHE  
 94 ZAPPE, ZAPPINI, ATTREZZINI e FORBICI  
 101 MANICI FIBRA  
 115 MANICI MIX e LEGNO  
 123 ASTE TELESCOPICHE  
 124 ESPOSITORI  
 126 GUANTI  
 140 SOLLEVAMENTO e ANCORAGGIO





**6 | Scopa per foglie in ferro denti tondi con manico in legno**

Iron broom for leaves round teeth with wooden handle  
 Balai à feuilles en fer dents rondes avec manche en bois

COD. ART.	DENTI	L mm	A mm	BOX	COD. EAN - 13
150 SF22F LE	22	1500	470	6	80 5773372 013 4
Mercato / Markets / Marchés  					



**8 | Scopa per foglie in ferro regolabile con manico ultraleggero in fibra di vetro**

Adjustable iron broom for leaves with ultralight fibreglass handle  
 Balai à feuilles en fer réglable renforcé pour feuilles avec manche creux super léger

COD. ART.	DENTI	L mm	A mm	BOX	COD. EAN - 13
150 SF22RF P	22	1500	470	6	80 5773372 014 1
Mercato / Markets / Marchés  					



**7 | Scopa per foglie in ferro regolabile**

Adjustable iron broom for leaves  
 Balai à feuilles en fer réglable renforcé pour feuilles

COD. ART.	DENTI	A mm	BOX	COD. EAN - 13
SF22RF	22	470	6	80 3264633 622 1
Mercato / Markets / Marchés  				

**9 | Scopa per foglie in ferro regolabile con manico in legno**

Adjustable iron broom for leaves with wooden handle  
 Balai à feuilles en fer réglable renforcé pour feuilles avec manche en bois

COD. ART.	DENTI	L mm	A mm	BOX	COD. EAN - 13
150 SF22RF LE	22	1500	470	6	80 5773372 015 8
Mercato / Markets / Marchés  					

# AUSTRALIAN

## PICK Up 2 in ONE



COD. ART.	DENTI	L mm	A mm	BOX	EURO
DRA	28x2	1650	560	1	34,53

  
MADE IN ITALY

NOVITÀ

## ROTORACC

Rotoracc è un attrezzo adatto alla raccolta di oggetti da terra, in quanto ruotando su di essi li imprigiona al suo interno

Il modello piccolo è indicato per frutti e oggetti di diametro da 10 a 30 mm (nocciole, olive...)

Il modello medio è indicato per frutti e oggetti di diametro da 25 a 65 mm (noci, palline da golf e tennis...)

*Rotoracc is a tool suitable for the collection of objects from the ground, rotating on them it traps them in its interior.*

*The small model is indicated for fruits or various objects with a diameter from 10 to 30 mm (hazelnuts, olives ...)*

*The medium model is indicated for fruits or various objects with a diameter from 25 to 65 mm (nuts, golf or tennis balls...)*

*Rotoracc est un outil qui peut être utilisé pour recueillir des objets du sol, en tournant sur eux il les emprisonne dans son intérieur.*

*Le modèle petit est indiqué pour les fruits ou objets avec un diamètre de 10 à 30 mm (noisettes, olives...)*

*Le modèle medium est indiqué pour les fruits ou objets avec un diamètre de 25 à 65 mm (noix, balles de golf ou de tennis...)*

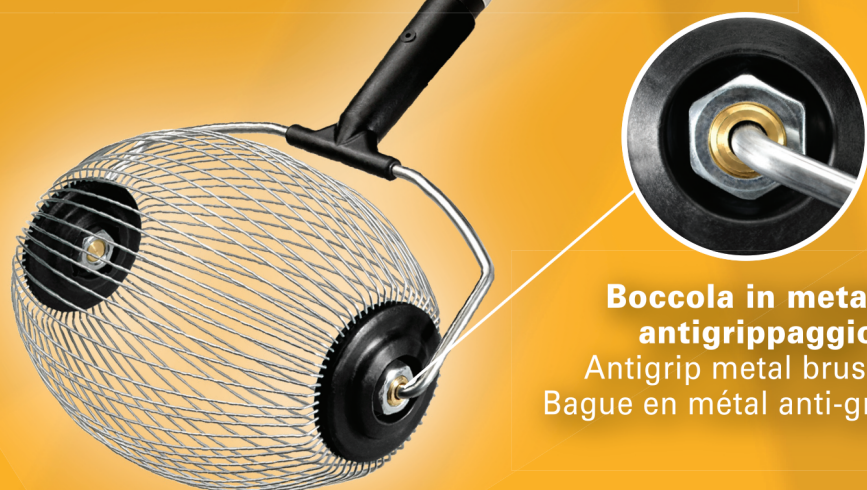

**Boccola in metallo antigrippaggio**  
Antigrip metal brushing  
Bague en métal anti-grippage





5

6

Divaricatore per secchio incluso  
Bucket's retractor included  
Crochet écarteur pour seau inclus

**1 Raccogliatore Rotoracc modello extra piccolo con manico ultraleggero in fibra di vetro**

Rotoracc gatherer extra small size with ultralight fiberglass handle  
Cueilleur Rotoracc modèle extra petit avec manche creux super léger

NEW

COD. ART.	LARGH. E DIAM. CESTELLO	LARGH. TOTALE	LUNGH. CON MANICO	COD. EAN - 13
REPP	220x155 mm	255 mm	170 cm	80 5773372 208 4
Mercato / Markets / Marchés				

**4 Raccogliatore Rotoracc modello piccolo con manico in legno**

Rotoracc gatherer small size with wooden handle  
Cueilleur Rotoracc modèle petit avec manche en bois

COD. ART.	LARGH. E DIAM. CESTELLO	LARGH. TOTALE	LUNGH. CON MANICO	COD. EAN - 13
RPL	220x175 mm	270 mm	174 cm	80 5773372 133 9
Mercato / Markets / Marchés				

**2 Raccogliatore Rotoracc modello extra piccolo con manico in legno**

Rotoracc gatherer extra small size with wooden handle  
Cueilleur Rotoracc modèle petit avec manche en bois

NEW

COD. ART.	LARGH. E DIAM. CESTELLO	LARGH. TOTALE	LUNGH. CON MANICO	COD. EAN - 13
REPL	220x155 mm	255 mm	170 cm	80 5773372 209 1
Mercato / Markets / Marchés				

**5 Raccogliatore Rotoracc modello extra piccolo senza manico**

Rotoracc gatherer extra small size without handle  
Cueilleur Rotoracc modèle extra petit sans manche

NEW

COD. ART.	LARGH. E DIAM. CESTELLO	LARGH. TOTALE	LUNGH. TOTALE	COD. EAN - 13
TREP	210x155 mm	250 mm	290 mm	80 5773372 184 1
Mercato / Markets / Marchés				

**3 Raccogliatore Rotoracc modello piccolo con manico ultraleggero in fibra di vetro**

Rotoracc gatherer small size with ultralight fiberglass handle  
Cueilleur Rotoracc modèle petit avec manche creux super léger

COD. ART.	LARGH. E DIAM. CESTELLO	LARGH. TOTALE	LUNGH. CON MANICO	COD. EAN - 13
RPP	220x175 mm	270 mm	174 cm	80 5773372 132 2
Mercato / Markets / Marchés				

**6 Raccogliatore Rotoracc modello piccolo senza manico**

Rotoracc gatherer small size without handle  
Cueilleur Rotoracc modèle petit sans manche

COD. ART.	LARGH. E DIAM. CESTELLO	LARGH. TOTALE	LUNGH. TOTALE	COD. EAN - 13
TRP	220x175 mm	270 mm	300 mm	80 5773372 136 0
Mercato / Markets / Marchés				

MARTELLERIA 4

MAZZE e PICCONI 20

SCALPELLI e LEVERINI 24

ARTICOLI PER PIETRA 26

SECCHI, CAZZUOLE, SPATOLE e VARIE 27

BADILI, PALE, RASCHIETTI e RASCHIAFANGO 39

ACCETTE, PICOZZINI, RONCOLE e MACETE 52

ASCE, MAZZESCURI e CUNEI 55

RASTRELLI, SARCHIATORI e AERATORI 61

SCOPE FOGLIE 69

RACCOLTA FRUTTA e TRATTAMENTO 78

NOVITÀ 84

FORCHE e VANGHE 90

ZAPPE, ZAPPINI, ATTREZZINI e FORBICI 94

MANICI FIBRA 101

MANICI MIX e LEGNO 115

ASTE TELESCOPICHE 123

ESPOSITORI 124

GUANTI 126

SOLLEVAMENTO e ANCORAGGIO 140

- 4 MARTELLERIA
- 20 MAZZE e PICCONI
- 24 SCALPELLI e LEVERINI
- 26 ARTICOLI PER PIETRA
- 27 SECCHI, CAZZUOLE, SPATOLE e VARIE
- 39 BADILI, PALE, RASCHIETTI e RASCHIAFANGO
- 52 ACCETTE, PICOZZINI, RONCOLE e MACETE
- 55 ASCE, MAZZESCURI e CUNEI
- 61 RASTRELLI, SARCHIATORI e AERATORI
- 69 SCOPE FOGLIE
- 78 **RACCOLTA FRUTTA e TRATTAMENTO**
- 84 NOVITÀ
- 90 FORCHE e VANGHE
- 94 ZAPPE, ZAPPINI, ATTREZZINI e FORBICI
- 101 MANICI FIBRA
- 115 MANICI MIX e LEGNO
- 123 ASTE TELESCOPICHE
- 124 ESPOSITORI
- 126 GUANTI
- 140 SOLLEVAMENTO e ANCORAGGIO



**7 Raccogliatore Rotoracc modello medio con manico ultraleggero in fibra di vetro**

Rotoracc gatherer medium size with ultralight fiberglass handle  
Cueilleur Rotoracc modèle moyen avec manche creux super léger

COD. ART.	LARGH. E DIAM. CESTELLO	LARGH. TOTALE	LUNGH. CON MANICO	COD. EAN - 13
RMP	260x215 mm	310 mm	178 cm	80 5773372 134 6
Mercato / Markets / Marchés				

**10 Raccogliatore Rotoracc modello grande con manico in legno**

Rotoracc gatherer big size with wooden handle  
Cueilleur Rotoracc modèle grand avec manche en bois

COD. ART.	LARGH. E DIAM. CESTELLO	LARGH. TOTALE	LUNGH. CON MANICO	COD. EAN - 13
RGL	260x215 mm	310 mm	178 cm	80 5773372 282 4
Mercato / Markets / Marchés				

**8 Raccogliatore Rotoracc modello medio con manico in legno**

Rotoracc gatherer medium size with wooden handle  
Cueilleur Rotoracc modèle moyen avec manche en bois

COD. ART.	LARGH. E DIAM. CESTELLO	LARGH. TOTALE	LUNGH. CON MANICO	COD. EAN - 13
RML	260x215 mm	310 mm	178 cm	80 5773372 135 3
Mercato / Markets / Marchés				

**11 Raccogliatore Rotoracc modello medio senza manico**

Rotoracc gatherer medium size without handle  
Cueilleur Rotoracc modèle moyen sans manche

COD. ART.	LARGH. E DIAM. CESTELLO	LARGH. TOTALE	LUNGH. TOTALE	COD. EAN - 13
TRM	260x215 mm	310 mm	340 mm	80 5773372 137 7
Mercato / Markets / Marchés				

**9 Raccogliatore Rotoracc modello grande con manico ultraleggero in fibra di vetro**

Rotoracc gatherer big size with ultralight fiberglass handle  
Cueilleur Rotoracc modèle grand avec manche creux super léger

COD. ART.	LARGH. E DIAM. CESTELLO	LARGH. TOTALE	LUNGH. CON MANICO	COD. EAN - 13
RGP	260x215 mm	310 mm	178 cm	80 5773372 281 7
Mercato / Markets / Marchés				

**12 Raccogliatore Rotoracc modello grande senza manico**

Rotoracc gatherer big size without handle  
Cueilleur Rotoracc modèle grand sans manche

COD. ART.	LARGH. E DIAM. CESTELLO	LARGH. TOTALE	LUNGH. TOTALE	COD. EAN - 13
TRG	260x215 mm	310 mm	340 mm	80 5773372 266 4
Mercato / Markets / Marchés				



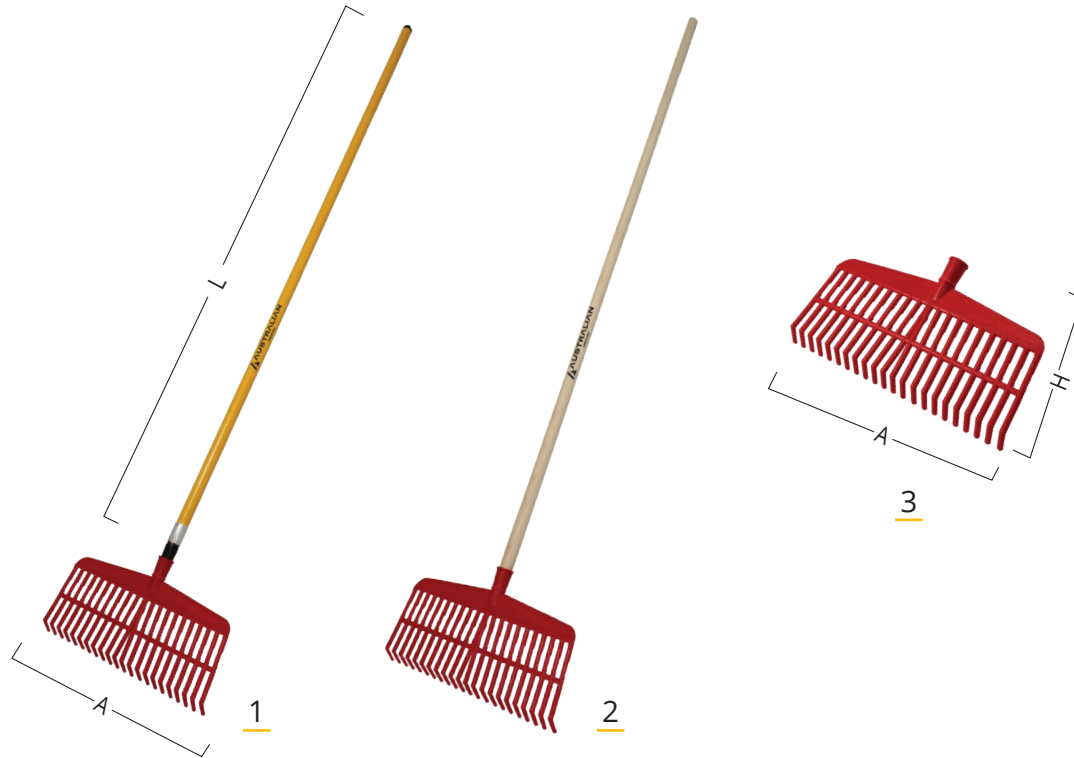



1 **Scopa per foglie / nocchie rettangolare in polipropilene con manico ultraleggero in fibra di vetro**

Polypropylene rectangular broom for leaves and hazelnuts with ultralight fiberglass handle  
Balai en polypropylène rectangulaire pour feuilles et noisettes avec manche creux super léger



COD. ART.	DENTI	L mm	A mm	BOX	COD. EAN - 13
150 SQF22 P	22	1500	450	6	80 3264633 861 4

Mercato / Markets / Marchés  

2 **Scopa per foglie / nocchie rettangolare in polipropilene con manico in legno**

Polyprop. rectangular broom for leaves and hazelnuts with wooden handle  
Balai en polyprop. rectangulaire pour feuilles et noisettes avec manche en bois



COD. ART.	DENTI	L mm	A mm	BOX	COD. EAN - 13
150 SQF22 LE	22	1500	450	6	80 3264633 816 4

Mercato / Markets / Marchés  

3 **Scopa per foglie / nocchie rettangolare in polipropilene**

Polypropylene rectangular broom for leaves and hazelnuts  
Balai en polypropylène rectangulaire pour feuilles et noisettes

COD. ART.	DENTI	A mm	H mm	BOX	COD. EAN - 13
SQF22	22	450	200	12	80 3264633 862 1

Mercato / Markets / Marchés  

MARTELLERIA	4
MAZZE e PICCONI	20
SCALPELLI e LEVERINI	24
ARTICOLI PER PIETRA	26
SECCHI, CAZZUOLE, SPATOLE e VARIE	27
BADILI, PALE, RASCHIETTI e RASCHIAFANGO	39
ACCETTE, PICOZZINI, RONCOLE e MACETE	52
ASCE, MAZZESCURI e CUNEI	55
RASTRELLI, SARCHIATORI e AERATORI	61
SCOPE FOGLIE	69
<b>RACCOLTA FRUTTA e TRATTAMENTO</b>	<b>78</b>
NOVITÀ	84
FORCHE e VANGHE	90
ZAPPE, ZAPPINI, ATTREZZINI e FORBICI	94
MANICI FIBRA	101
MANICI MIX e LEGNO	115
ASTE TELESCOPICHE	123
ESPOSITORI	124
GUANTI	126
SOLLEVAMENTO e ANCORAGGIO	140

- 4 MARTELLERIA
- 20 MAZZE e PICCONI
- 24 SCALPELLI e LEVERINI
- 26 ARTICOLI PER PIETRA
- 27 SECCHI, CAZZUOLE, SPATOLE e VARIE
- 39 BADILI, PALE, RASCHIETTI e RASCHIAFANGO
- 52 ACCETTE, PICOZZINI, RONCOLE e MACETE
- 55 ASCE, MAZZESCURI e CUNEI
- 61 RASTRELLI, SARCHIATORI e AERATORI
- 69 SCOPE FOGLIE
- 78 **RACCOLTA FRUTTA e TRATTAMENTO**
- 84 NOVITÀ
- 90 FORCHE e VANGHE
- 94 ZAPPE, ZAPPINI, ATTREZZINI e FORBICI
- 101 MANICI FIBRA
- 115 MANICI MIX e LEGNO
- 123 ASTE TELESCOPICHE
- 124 ESPOSITORI
- 126 GUANTI
- 140 SOLLEVAMENTO e ANCORAGGIO



**1 Rastrellino per olive polipropilene 9 denti, 14 cm con manico ultraleggero in fibra di vetro**

Polyprop. mini-rake for olives 9 teeth, 14 cm with ultralight handle  
Mini râteau en polyprop. pour olives 9 dents, 14cm avec manche creux super léger

COD. ART.	DENTI	L mm	A mm	BOX	COD. EAN - 13
120 ROS9 P	9	1200	140	6	80 3264633 959 8
150 ROS9 P	9	1500	140	6	80 3264633 960 4
180 ROS9 P	9	1800	140	6	80 3264633 961 1

Mercato / Markets / Marchés

**2 Rastrellino per olive polipropilene 9 denti 14 cm con manico in legno**

Polypropylene mini-rake for olives 9 teeth, 14 cm with wooden handle  
Mini râteau en polyprop. pour olives 9 dents, 14 cm avec manche en bois

COD. ART.	DENTI	L mm	A mm	BOX	COD. EAN - 13
150 ROS9 LE	9	1500	140	6	80 3264633 962 8
180 ROS9 LE	9	1800	140	6	80 3264633 963 5

Mercato / Markets / Marchés

**3 Rastrellino per olive polipropilene 9 denti cm. 14**

Polypropylene mini-rake for olives 9 teeth, 14 cm  
Mini râteau en polypropylène pour olives 9 dents, 14 cm

COD. ART.	DENTI	A mm	H mm	BOX	COD. EAN - 13
ROS9	9	170	250	24	80 3264633 906 2

Mercato / Markets / Marchés

### Spollonatore Ø 100 (accessorio per decespugliatore) adatto al taglio di polloni dagli alberi

Trimmer Ø 100 (brush cutter's tool) suitable to the cut of suckers from trees

Lame Ø 100 (accessoire pour débroussailluse) apte à la taille des pousses au pied des arbres

COD. ART.	Ø Disco mm	BOX	COD. EAN - 13
S100	100	1	80 5773372 097 4

Mercato / Markets / Marchés 



ATTACCO UNIVERSALE  
Universal connection  
Fixation universelle

### Spollonatore Ø 150 (accessorio per decespugliatore) adatto al taglio di polloni dagli alberi

Trimmer Ø 150 (brush cutter's tool) suitable to the cut of suckers from trees

Lame Ø 150 (accessoire pour débroussailluse) apte à la taille des pousses au pied des arbres

COD. ART.	Ø Disco mm	BOX	COD. EAN - 13
S150	150	1	80 5773372 098 1

Mercato / Markets / Marchés 



MARTELLERIA 4

MAZZE e PICCONI 20

SCALPELLI e LEVERINI 24

ARTICOLI PER PIETRA 26

SECCHI, CAZZUOLE, SPATOLE e VARIE 27

BADILI, PALE, RASCHIETTI e RASCHIAFANGO 39

ACCETTE, PICOZZINI, RONCOLE e MACETE 52

ASCE, MAZZESCURI e CUNEI 55

RASTRELLI, SARCHIATORI e AERATORI 61

SCOPE FOGLIE 69

**RACCOLTA FRUTTA e TRATTAMENTO 78**

NOVITÀ 84

FORCHE e VANGHE 90

ZAPPE, ZAPPINI, ATTREZZINI e FORBICI 94

MANICI FIBRA 101

MANICI MIX e LEGNO 115

ASTE TELESCOPICHE 123

ESPOSITORI 124

GUANTI 126

SOLLEVAMENTO e ANCORAGGIO 140

**NEW**

**Spazzola Ø 150 (accessorio per decespugliatore)**

Weed trimmer Ø 150 (brush cutter's tool)  
Lame Ø 150 (accessoire pour débroussailluse)

COD. ART.	Ø Disco mm	BOX	COD. EAN - 13
SPZ150	150	1	80 5773372 292 3

Mercato / Markets / Marchés 



ATTACCO UNIVERSALE  
Universal connection  
Fixation universelle

**NEW**

**Spazzola Ø 200 (accessorio per decespugliatore)**

Weed trimmer Ø 200 (brush cutter's tool)  
Brosse de désherbage Ø 200 (accessoire pour débroussailluse)

COD. ART.	Ø Disco mm	BOX	COD. EAN - 13
SPZ200	200	1	80 5773372 293 0

Mercato / Markets / Marchés 



4 MARTELLERIA

20 MAZZE e PICCONI

24 SCALPELLI e LEVERINI

26 ARTICOLI PER PIETRA

27 SECCHI, CAZZUOLE, SPATOLE e VARIE

39 BADILI, PALE, RASCHIETTI e RASCHIAFANGO

52 ACCETTE, PICOZZINI, RONCOLE e MACETE

55 ASCE, MAZZESCURI e CUNEI

61 RASTRELLI, SARCHIATORI e AERATORI

69 SCOPE FOGLIE

78 RACCOLTA FRUTTA e TRATTAMENTO

84 **NOVITÀ**

90 FORCHE e VANGHE

94 ZAPPE, ZAPPINI, ATTREZZINI e FORBICI

101 MANICI FIBRA

115 MANICI MIX e LEGNO

123 ASTE TELESCOPICHE

124 ESPOSITORI

126 GUANTI

140 SOLLEVAMENTO e ANCORAGGIO



NEW

**Disco tagliaerba - arbusti Ø 255 a 32 denti (accessorio per decespugliatore)**

Weed trimmer blade Ø 255 - 32 teeth (brush cutter's tool)  
Lame Ø 255 - 32 dents (accessoire pour débroussailleuse)

COD. ART.	Ø Disco mm	BOX	COD. EAN - 13
DTE255	225	1	80 5773372 361 6
Mercato / Markets / Marchés			

PRODOTTO IN ITALIA  
Made in Italy  
Produit en Italie

QUALITÀ GARANTITA  
Guaranteed quality  
Qualité garantie



ATTACCO UNIVERSALE  
Universal connection  
Fixation universelle

ACCIAIO ARMONICO  
Harmonic steel  
Acier harmonique

**ADATTO AL TAGLIO DI ERBA, ARBUSTI E ROVI**

Grazie alla sua fitta dentatura evita il lancio di sassi e rifiuti in prossimità di pedoni e veicoli

**Weed and shrubs cutting tool:** thanks to its thick teeth it avoids throwing stones and waste in the vicinity of pedestrians and vehicles.

**Pour l'herbe et les arbustes:** grâce à ses dents denses, il évite de jeter des pierres et des déchets à proximité des piétons et des véhicules.



MARTELLERIA	4
MAZZE e PICCONI	20
SCALPELLI e LEVERINI	24
ARTICOLI PER PIETRA	26
SECCHI, CAZZUOLE, SPATOLE e VARIE	27
BADILI, PALE, RASCHIETTI e RASCHIAFANGO	39
ACCETTE, PICOZZINI, RONCOLE e MACETE	52
ASCE, MAZZESCURI e CUNEI	55
RASTRELLI, SARCHIATORI e AERATORI	61
SCOPE FOGLIE	69
RACCOLTA FRUTTA e TRATTAMENTO	78
<b>NOVITÀ</b>	<b>84</b>
FORCHE e VANGHE	90
ZAPPE, ZAPPINI, ATTREZZINI e FORBICI	94
MANICI FIBRA	101
MANICI MIX e LEGNO	115
ASTE TELESCOPICHE	123
ESPOSITORI	124
GUANTI	126
SOLLEVAMENTO e ANCORAGGIO	140

- 4 MARTELLERIA
- 20 MAZZE e PICCONI
- 24 SCALPELLI e LEVERINI
- 26 ARTICOLI PER PIETRA
- 27 SECCHI, CAZZUOLE, SPATOLE e VARIE
- 39 BADILI, PALE, RASCHIETTI e RASCHIAFANGO
- 52 ACCETTE, PICOZZINI, RONCOLE e MACETE
- 55 ASCE, MAZZESCURI e CUNEI
- 61 RASTRELLI, SARCHIATORI e AERATORI
- 69 SCOPE FOGLIE
- 78 RACCOLTA FRUTTA e TRATTAMENTO
- 84 NOVITÀ**
- 90 FORCHE e VANGHE
- 94 ZAPPE, ZAPPINI, ATTREZZINI e FORBICI
- 101 MANICI FIBRA
- 115 MANICI MIX e LEGNO
- 123 ASTE TELESCOPICHE
- 124 ESPOSITORI
- 126 GUANTI
- 140 SOLLEVAMENTO e ANCORAGGIO



NEW

### Adattatore in plastica per cisterne tipo cubo da 1000 lt da filetto grande mm 60 a filetto idraulico

Plastic adapter for tanks, 1000 lt cube model, from big thread mm 60 to hydraulic thread 1"  
Adaptateur en plastique pour citernes, modèle cube 1000 lt, de grand filet mm 60 à filet

COD. ART.	Filetto grande	Filetto piccolo	BOX	COD. EAN - 13
R1PFV	60 mm	1"	1	8057733722985
R1P1/4FV	60 mm	1" 1/4	1	8057733724095

Mercato / Markets / Marchés

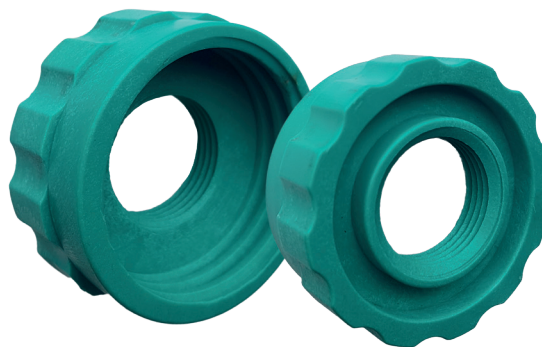

### Adattatore in alluminio per cisterne tipo cubo da 1000 lt da filetto grande mm 60 a filetto idraulico

Aluminium adapter for tanks, 1000 lt cube model, from big thread mm 60 to hydraulic thread 1"  
Adaptateur en aluminium pour citernes, modèle cube 1000 lt, de grand filet mm 60 à filet

COD. ART.	Filetto grande	Filetto piccolo	BOX	COD. EAN - 13
R1P	60 mm	1"	1	8057733721612

Mercato / Markets / Marchés



MARTELLERIA	4
MAZZE e PICCONI	20
SCALPELLI e LEVERINI	24
ARTICOLI PER PIETRA	26
SECCHI, CAZZUOLE, SPATOLE e VARIE	27
BADILI, PALE, RASCHIETTI e RASCHIAFANGO	39
ACCETTE, PICOZZINI, RONCOLE e MACETE	52
ASCE, MAZZESCURI e CUNEI	55
RASTRELLI, SARCHIATORI e AERATORI	61
SCOPE FOGLIE	69
RACCOLTA FRUTTA e TRATTAMENTO	78
<b>NOVITÀ</b>	<b>84</b>
FORCHE e VANGHE	90
ZAPPE, ZAPPINI, ATTREZZINI e FORBICI	94
MANICI FIBRA	101
MANICI MIX e LEGNO	115
ASTE TELESCOPICHE	123
ESPOSITORI	124
GUANTI	126
SOLLEVAMENTO e ANCORAGGIO	140

- 4 MARTELLERIA
- 20 MAZZE e PICCONI
- 24 SCALPELLI e LEVERINI
- 26 ARTICOLI PER PIETRA
- 27 SECCHI, CAZZUOLE, SPATOLE e VARIE
- 39 BADILI, PALE, RASCHIETTI e RASCHIAFANGO
- 52 ACCETTE, PICOZZINI, RONCOLE e MACETE
- 55 ASCE, MAZZESCURI e CUNEI
- 61 RASTRELLI, SARCHIATORI e AERATORI
- 69 SCOPE FOGLIE
- 78 RACCOLTA FRUTTA e TRATTAMENTO
- 84 **NOVITÀ**
- 90 FORCHE e VANGHE
- 94 ZAPPE, ZAPPINI, ATTREZZINI e FORBICI
- 101 MANICI FIBRA
- 115 MANICI MIX e LEGNO
- 123 ASTE TELESCOPICHE
- 124 ESPOSITORI
- 126 GUANTI
- 140 SOLLEVAMENTO e ANCORAGGIO

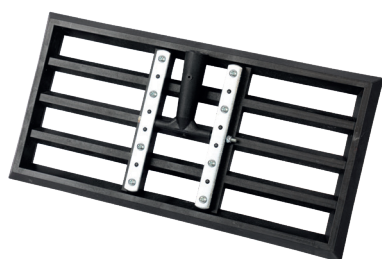

1



2



3

**1 Rastrello livellatore per spargere uniformemente sabbia e concime**

Leveling rake to spread uniformly sand and fertilizer  
Râteau niveleur pour répartir uniformément sable et engrais

COD. ART.	gr	A mm	B mm	BOX	COD. EAN - 13
RLPL	1400	500	250	6	80 5773372 603 7

Mercato / Markets / Marchés

**3 Rastrello livellatore con manico in legno**

Leveling rake with ultralight wooden handle  
Râteau niveleur avec manche en bois

COD. ART.	gr	L mm	A mm	B mm	BOX	COD. EAN - 13
180 RPLPe	1850	1800	500	250	6	80 5773372 741 6

Mercato / Markets / Marchés

**2 Rastrello livellatore con manico ultraleggero in fibra di vetro**

Leveling rake with ultralight fiberglass handle  
Râteau niveleur avec manche en fibre de verre creux super léger

COD. ART.	gr	L mm	A mm	B mm	BOX	COD. EAN - 13
180 RPLP	1950	1800	500	250	6	80 5773372 740 9

Mercato / Markets / Marchés



DISPONIBILE  
IN DIVERSI  
COLORI



NEW

**Bastone per allevatori in polipropilene**

Polypropylene shepherd's cane  
Bâton de berger en polypropylène

COD. ART.	L mm	BOX	COD. EAN - 13
BAP	900	6	80 5773372 333 3
Mercato / Markets / Marchés			EU

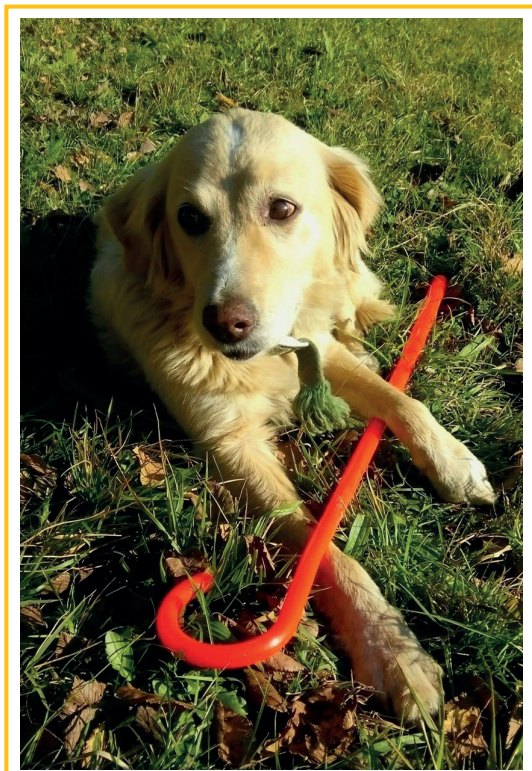

MARTELLERIA	4
MAZZE e PICCONI	20
SCALPELLI e LEVERINI	24
ARTICOLI PER PIETRA	26
SECCHI, CAZZUOLE, SPATOLE e VARIE	27
BADILI, PALE, RASCHIETTI e RASCHIAFANGO	39
ACCETTE, PICOZZINI, RONCOLE e MACETE	52
ASCE, MAZZESCURI e CUNEI	55
RASTRELLI, SARCHIATORI e AERATORI	61
SCOPE FOGLIE	69
RACCOLTA FRUTTA e TRATTAMENTO	78
<b>NOVITÀ</b>	<b>84</b>
FORCHE e VANGHE	90
ZAPPE, ZAPPINI, ATTREZZINI e FORBICI	94
MANICI FIBRA	101
MANICI MIX e LEGNO	115
ASTE TELESCOPICHE	123
ESPOSITORI	124
GUANTI	126
SOLLEVAMENTO e ANCORAGGIO	140

- 4 MARTELLERIA
- 20 MAZZE e PICCONI
- 24 SCALPELLI e LEVERINI
- 26 ARTICOLI PER PIETRA
- 27 SECCHI, CAZZUOLE, SPATOLE e VARIE
- 39 BADILI, PALE, RASCHIETTI e RASCHIAFANGO
- 52 ACCETTE, PICOZZINI, RONCOLE e MACETE
- 55 ASCE, MAZZESCURI e CUNEI
- 61 RASTRELLI, SARCHIATORI e AERATORI
- 69 SCOPE FOGLIE
- 78 RACCOLTA FRUTTA e TRATTAMENTO
- 84 NOVITÀ
- 90 **FORCHE e VANGHE**
- 94 ZAPPE, ZAPPINI, ATTREZZINI e FORBICI
- 101 MANICI FIBRA
- 115 MANICI MIX e LEGNO
- 123 ASTE TELESCOPICHE
- 124 ESPOSITORI
- 126 GUANTI
- 140 SOLLEVAMENTO e ANCORAGGIO



**1 Forca per cavalli in ABS con manico ultraleggero in fibra di vetro**

ABS fork for horses with ultralight fibreglass handle  
Fourche pour chevaux en ABS avec manche creux super léger

COD. ART.	DENTI	L mm	A mm	B mm	Gr.	BOX	COD. EAN - 13
150 FC P	16	1500	450	350	1035	6	80 3264633 974 1
Mercato / Markets / Marchés							

**2 Forca per cavalli in ABS con manico in legno**

ABS fork for horses with wooden handle  
Fourche pour chevaux en ABS avec manche en bois

COD. ART.	DENTI	L mm	A mm	B mm	Gr.	BOX	COD. EAN - 13
150 FC LE	16	1500	450	350	1080	6	80 3264633 975 8
Mercato / Markets / Marchés							

**3 Forca in acciaio temprato a 3 denti con manico in fibra di vetro ultraleggero**

3 pronged hardened steel fork with ultralight fibreglass handle  
Fourche en acier trempé avec 3 dents, manche en fibre de verre creux super léger

COD. ART.	DENTI	L mm	A mm	B mm	Gr.	BOX	COD. EAN - 13
F3 D 130 P	3	1300	250	350	1300	6	80 3264633 964 2
F3 D 140 P	3	1400	250	350	1350	6	80 3264633 965 9
Mercato / Markets / Marchés							

**4 Forca in acciaio temprato a 3 denti con manico in legno**

3 pronged hardened steel fork with wooden handle  
Fourche en acier trempé avec 3 dents, manche en bois

COD. ART.	DENTI	L mm	A mm	B mm	Gr.	BOX	COD. EAN - 13
F3 D 140 LE	3	1400	250	350	1580	6	80 3264633 968 0
Mercato / Markets / Marchés							

**5 Forca in acciaio temprato a 4 denti con manico in fibra di vetro ultraleggero**

4 pronged hardened steel fork with ultralight fibreglass handle  
Fourche en acier trempé avec 4 dents manche fibre de verre creux super léger

COD. ART.	DENTI	L mm	A mm	B mm	Gr.	BOX	COD. EAN - 13
F4 D 130 P	4	1300	250	350	1430	6	80 3264633 966 6
F4 D 140 P	4	1400	250	350	1480	6	80 3264633 967 3
Mercato / Markets / Marchés							

**6 Forca in acciaio temprato a 4 denti con manico in legno**

4 pronged hardened steel fork with wooden handle  
Fourche en acier trempé avec 4 dents, manche en bois



COD. ART.	DENTI	L mm	A mm	B mm	Gr.	BOX	COD. EAN - 13
F4 D 140 LE	4	1400	250	350	1710	6	80 3264633 971 0
Mercato / Markets / Marchés							



**7 Forca a vangare in acciaio temprato con manico in fibra di vetro ultraleggero**

Hardened steel spading fork with ultralight fibreglass handle  
Fourche à bêcher en acier trempé avec manche en fibre de verre creux super léger



COD. ART.	DENTI	L mm	A mm	B mm	Gr.	BOX	COD. EAN - 13
140 FV VP	4	1400	230	330	1900	6	80.3264633.492.0

Mercato / Markets / Marchés  

**8 Forca a vangare in acciaio temprato con manico in legno**

Hardened steel spading fork with wooden handle  
Fourche à bêcher en acier trempé avec manche en bois



COD. ART.	DENTI	L mm	A mm	B mm	Gr.	BOX	COD. EAN - 13
140 FV LE	4	1400	230	330	2350	6	80.5773372.294.7

Mercato / Markets / Marchés  

**9 Forca a vangare in acciaio temprato con manico a "T" in fibra di vetro ultraleggero**

Hardened steel spading fork with ultralight fibreglass "T" handle  
Fourche à bêcher en acier trempé avec manche à "T" en fibre de verre creux super léger



COD. ART.	DENTI	L mm	A mm	B mm	Gr.	BOX	COD. EAN - 13
90 FV TBP	4	950	230	330	1850	6	80.3264633.493.7

Mercato / Markets / Marchés  

**10 Forca a vangare in acciaio temprato con manico a "T" in resina, impugnatura gomma**

Hardened steel spading fork with resin "T" handle and rubber coated handgrip  
Fourche à bêcher en acier trempé avec manche à "T" en resine, poignée en élastomère



COD. ART.	DENTI	L mm	A mm	B mm	Gr.	BOX	COD. EAN - 13
95 FV TVG	4	950	230	330	1900	6	80.3264633.978.9

Mercato / Markets / Marchés  

**11 Forca a vangare in acciaio temprato con manico curvo a "T" in resina (impugnatura gomma)**

Hardened steel spading fork with curved resin "T" handle, rubber grip  
Fourche à bêcher en acier trempé avec manche à "T" cintré en resine, poignée en élastomère



COD. ART.	DENTI	L mm	A mm	B mm	Gr.	BOX	COD. EAN - 13
95 FV TBG	4	950	230	330	1900	6	80.3264633.977.2

Mercato / Markets / Marchés  

**12 Forca a vangare in acciaio temprato con manico curvo a "D" in fibra di vetro ultraleggero**

Hardened steel spading fork with ultralight fibreglass "D" shaped handle  
Fourche à bêcher en acier trempé avec manche à "D" en fibre de verre creux super léger

COD. ART.	DENTI	L mm	A mm	B mm	Gr.	BOX	COD. EAN - 13
90 FV DBP	4	900	230	330	1900	3	80.57737.2599.3

Mercato / Markets / Marchés  

MARTELLERIA	4
MAZZE e PICCONI	20
SCALPELLI e LEVERINI	24
ARTICOLI PER PIETRA	26
SECCHI, CAZZUOLE, SPATOLE e VARIE	27
BADILI, PALE, RASCHIETTI e RASCHIAFANGO	39
ACCETTE, PICOZZINI, RONCOLE e MACETE	52
ASCE, MAZZESCURI e CUNEI	55
RASTRELLI, SARCHIATORI e AERATORI	61
SCOPE FOGLIE	69
RACCOLTA FRUTTA e TRATTAMENTO	78
NOVITÀ	84
<b>FORCHE e VANGHE</b>	<b>90</b>
ZAPPE, ZAPPINI, ATTREZZINI e FORBICI	94
MANICI FIBRA	101
MANICI MIX e LEGNO	115
ASTE TELESCOPICHE	123
ESPOSITORI	124
GUANTI	126
SOLLEVAMENTO e ANCORAGGIO	140

4 MARTELLERIA  
20 MAZZE e PICCONI  
24 SCALPELLI e LEVERINI  
26 ARTICOLI PER PIETRA  
27 SECCHI, CAZZUOLE, SPATOLE e VARIE  
39 BADILI, PALE, RASCHIETTI e RASCHIAFANGO  
52 ACCETTE, PICOZZINI, RONCOLE e MACETE  
55 ASCE, MAZZESCURI e CUNEI  
61 RASTRELLI, SARCHIATORI e AERATORI  
69 SCOPE FOGLIE  
78 RACCOLTA FRUTTA e TRATTAMENTO  
84 NOVITÀ  
90 **FORCHE e VANGHE**  
94 ZAPPE, ZAPPINI, ATTREZZINI e FORBICI  
101 MANICI FIBRA  
115 MANICI MIX e LEGNO  
123 ASTE TELESCOPICHE  
124 ESPOSITORI  
126 GUANTI  
140 SOLLEVAMENTO e ANCORAGGIO



**1 Vanga a punta in acciaio temprato con manico fibra di vetro ultraleggero**

Hardened pointed spade with ultralight fibreglass handle  
Beche pointu en acier trempé avec manche en fibre de verre creux super léger

COD. ART.	L mm	A mm	B mm	Gr.	BOX	COD. EAN - 13
VE 140 P	1400	230	300	1700	6	80 3264633 981 9
Mercato / Markets / Marchés						

**2 Vanga a punta in acciaio temprato con manico in legno**

Hardened pointed spade with wooden handle  
Beche pointu en acier trempé avec manche en bois

COD. ART.	L mm	A mm	B mm	Gr.	BOX	COD. EAN - 13
VE 140 LE	1400	230	300	2000	6	80 3264633 982 6
Mercato / Markets / Marchés						

**3 Vanga quadrata in acciaio temprato con manico in fibra ultraleggero**

Square hardened steel spade with ultralight fibreglass handle  
Beche carré en acier trempé avec manche en fibre de verre creux super léger

COD. ART.	L mm	A mm	B mm	Gr.	BOX	COD. EAN - 13
110VFP	1100	200	280	1750	6	80 5773372 158 2
Mercato / Markets / Marchés						

**4 Vanga quadrata in acciaio temprato con manico a T in fibra di vetro (impugnatura in gomma)**

Square hardened steel spade with "T" shaped fibreglass handle rubber haft  
Beche carré en acier trempé avec manche trimatière en "T"

COD. ART.	L mm	A mm	B mm	Gr.	BOX	COD. EAN - 13
90VFTBG	900	200	280	2000	6	80 5773372 159 9
Mercato / Markets / Marchés						

**5 Vanga a punta in acciaio temprato con manico in fibra di vetro ultraleggero e impugnatura a "D"**

Hardened pointed spade with ultralight fibreglass handle and "D" shaped grip  
Beche pointu en acier trempé manche en fibre de verre creux et poignée a "D"

COD. ART.	L mm	A mm	B mm	Gr.	BOX	COD. EAN - 13
90VEDBP	900	230	300	1650	3	8 03264633 498 6
Mercato / Markets / Marchés						

**6 Vanga quadrata in acciaio temprato con manico in fibra di vetro ultraleggero e impugnatura a "D"**

Hardened squared steel spade with "D" shaped fibreglass handle rubber haft  
Beche carré en acier trempé manche en fibre de verre creux et poignée a "D"

COD. ART.	L mm	A mm	B mm	Gr.	BOX	COD. EAN - 13
90VDBP	900	200	280	1650	3	8 05773372 598 6
Mercato / Markets / Marchés						



**Forca per cavalli in ABS**



ABS fork for horses  
Fourche pour chevaux en ABS

COD. ART.	DENTI	A mm	B mm	Gr.	BOX	COD. EAN - 13
FC	16	450	350	520	12	80 3264633 976 5
Mercato / Markets / Marchés  						



**Forca a vangare in acciaio temprato**



Hardened steel spading fork  
Forche à bêcher en acier trempé

COD. ART.	DENTI	A mm	B mm	Gr.	BOX	COD. EAN - 13
FV	4	230	330	1150	12	80 3264633 980 2
Mercato / Markets / Marchés  						



**Forca in acciaio temprato a tre denti**

3 pronged hardened steel fork  
Fourche en acier trempé avec 3 dents

COD. ART.	DENTI	A mm	B mm	Gr.	BOX	COD. EAN - 13
F3D	3	250	350	580	6	80 3264633 972 7
Mercato / Markets / Marchés  						



**Vanga a punta in acciaio temprato**



Hardened pointed spade  
Beche pointu en acier trempé

COD. ART.	A mm	B mm	Gr.	BOX	COD. EAN - 13
VE	230	300	1000	12	80 3264633 983 3
Mercato / Markets / Marchés 					



**Forca in acciaio temprato a 4 denti**

4 pronged hardened steel fork  
Fourche en acier trempé avec 4 dents

COD. ART.	DENTI	A mm	B mm	Gr.	BOX	COD. EAN - 13
F4D	4	250	350	710	6	80 3264633 973 4
Mercato / Markets / Marchés  						



**Vanga quadrata francese**

Square French spade  
Beche carré français

COD. ART.	Gr.	BOX	COD. EAN - 13
VF28	1000	12	80 5773372 160 5
Mercato / Markets / Marchés 			

MARTELLERIA	4
MAZZE e PICCONI	20
SCALPELLI e LEVERINI	24
ARTICOLI PER PIETRA	26
SECCHI, CAZZUOLE, SPATOLE e VARIE	27
BADILI, PALE, RASCHIETTI e RASCHIAFANGO	39
ACCETTE, PICOZZINI, RONCOLE e MACETE	52
ASCE, MAZZESCURI e CUNEI	55
RASTRELLI, SARCHIATORI e AERATORI	61
SCOPE FOGLIE	69
RACCOLTA FRUTTA e TRATTAMENTO	78
NOVITÀ	84
<b>FORCHE e VANGHE</b>	<b>90</b>
ZAPPE, ZAPPINI, ATTREZZINI e FORBICI	94
MANICI FIBRA	101
MANICI MIX e LEGNO	115
ASTE TELESCOPICHE	123
ESPOSITORI	124
GUANTI	126
SOLLEVAMENTO e ANCORAGGIO	140

- 4 MARTELLERIA
- 20 MAZZE e PICCONI
- 24 SCALPELLI e LEVERINI
- 26 ARTICOLI PER PIETRA
- 27 SECCHI, CAZZUOLE, SPATOLE e VARIE
- 39 BADILI, PALE, RASCHIETTI e RASCHIAFANGO
- 52 ACCETTE, PICOZZINI, RONCOLE e MACETE
- 55 ASCE, MAZZESCURI e CUNEI
- 61 RASTRELLI, SARCHIATORI e AERATORI
- 69 SCOPE FOGLIE
- 78 RACCOLTA FRUTTA e TRATTAMENTO
- 84 NOVITÀ
- 90 FORCHE e VANGHE
- 94 ZAPPE, ZAPPINI, ATTREZZINI e FORBICI
- 101 MANICI FIBRA
- 115 MANICI MIX e LEGNO
- 123 ASTE TELESCOPICHE
- 124 ESPOSITORI
- 126 GUANTI
- 140 SOLLEVAMENTO e ANCORAGGIO



**1 Zappa quadrata in acciaio forgiato con manico in fibra di vetro ultraleggero**

Forged square hoe with ultralight fiberglass handle  
Houe carrée forgée avec manche en fibre de verre creux super léger

COD. ART.	L mm	A mm	B mm	Gr.	BOX	COD. EAN - 13
130 ZQ4 P	1300	75	125	400	6	80 5773372 019 6
140 ZQ6 P	1400	105	155	600	6	80 5773372 020 2
140 ZQ P	1400	120	190	800	6	80 3264633 991 8
140 ZQ10 P	1400	140	205	1000	6	80 5773372 021 9

Mercato / Markets / Marchés

**2 Zappa quadrata in acciaio forgiato con manico in legno Mix**

Forged square hoe with wooden Mix handle  
Houe carrée forgée avec manche en bois Mix

COD. ART.	L mm	A mm	B mm	Gr.	BOX	COD. EAN - 13
130 ZQ4 MIX	1300	75	125	400	6	80 5773372 022 6
140 ZQ6 MIX	1400	105	155	600	6	80 5773372 023 3
140 ZQ MIX	1400	120	190	800	6	80 3264633 992 5
140 ZQ10 MIX	1400	140	205	1000	6	80 5773372 024 0

Mercato / Markets / Marchés

**3 Zappa quadrata in acciaio forgiato con manico in legno**

Forged square hoe with wooden handle  
Houe carrée forgée avec manche en bois

COD. ART.	L mm	A mm	B mm	Gr.	BOX	COD. EAN - 13
130 ZQ4 LE	1300	75	125	400	6	80 5773372 355 5
140 ZQ6 LE	1400	105	155	600	6	80 5773372 356 2
140 ZQ LE	1400	120	190	800	6	80 5773372 287 9
140 ZQ10 LE	1400	140	205	1000	6	80 5773372 357 9

Mercato / Markets / Marchés

**4 Zappa triangolare in acciaio forgiato con manico in fibra di vetro ultraleggero**

Polypropylene spoon shovel with "T" shaped ultralight fiberglass handle  
Pelle en polyprop. à cuillère avec manche creux super léger à "T" en fibre de verre

COD. ART.	L mm	A mm	B mm	Gr.	BOX	COD. EAN - 13
140 ZT P	1400	190	190	600	6	80 3264633 995 6
140 ZT8 P	1400	220	220	800	6	80 5773372 025 7
140 ZT10 P	1400	240	240	1000	6	80 5773372 026 4

Mercato / Markets / Marchés

**5 Zappa triangolare in acciaio forgiato con manico legno Mix**

Forged triangular hoe with wooden Mix handle  
Houe triangulaire forgée avec manche en bois Mix

COD. ART.	L mm	A mm	B mm	Gr.	BOX	COD. EAN - 13
140 ZT MIX	1400	190	190	600	6	80 3264633 996 3
140 ZT8 MIX	1400	220	220	800	6	80 5773372 027 1
140 ZT10 MIX	1400	240	240	1000	6	80 5773372 028 8

Mercato / Markets / Marchés

**6 Zappa triangolare in acciaio forgiato con manico legno**

Forged triangular hoe with wooden handle  
Houe triangulaire forgée avec manche en bois

COD. ART.	L mm	A mm	B mm	Gr.	BOX	COD. EAN - 13
140 ZT LE	1400	190	190	600	6	80 5773372 358 6
140 ZT8 LE	1400	220	220	800	6	80 5773372 359 3
140 ZT10 LE	1400	240	240	1000	6	80 5773372 360 9



Mercato / Markets / Marchés



7 **Zappino quadrato bidente in acciaio forgiato con manico in fibra di vetro ultraleggero**

Two-pronged square forged weeding-hoe with ultralight fibreglass handle  
Serfouette carrée forgée bidente, manche en fibre de verre creux super léger



COD. ART.	L mm	A mm	B mm	Gr.	BOX	COD. EAN - 13
120 ZQB P	1200	80	280	940	6	80 3264633 998 7
130 ZQB P	1300	80	280	950	6	80 3264633 999 4

Mercato / Markets / Marchés  

8 **Zappino quadrato bidente in acciaio forgiato con manico legno Mix**

Two-pronged square forged weeding-hoe with wooden Mix handle  
Serfouette carrée forgée bidente avec manche en bois Mix



COD. ART.	L mm	A mm	B mm	Gr.	BOX	COD. EAN - 13
130 ZQB MIX	1300	80	280	1050	6	80 3264633 015 1

Mercato / Markets / Marchés  

9 **Zappino quadrato bidente in acciaio forgiato con manico legno**

Two-pronged square forged weeding-hoe with wooden handle  
Serfouette carrée forgée bidente avec manche en bois



COD. ART.	L mm	A mm	B mm	Gr.	BOX	COD. EAN - 13
130 ZQB LE	1300	80	280	1050	6	80 5773372 295 4

Mercato / Markets / Marchés  

10 **Zappino a cuore bidente in acciaio forgiato con manico in fibra di vetro ultraleggero**

Two-pronged heart-shaped forged weeding-hoe with ultralight fibreglass handle  
Serfouette à coeur forgée bidente avec manche en fibre de verre creux super léger



COD. ART.	L mm	A mm	B mm	Gr.	BOX	COD. EAN - 13
120 ZCB P	1200	110	280	940	6	80 3264633 124 0
130 ZCB P	1300	110	280	950	6	80 3264633 177 6

Mercato / Markets / Marchés  

11 **Zappino a cuore bidente in acciaio forgiato con manico legno Mix**

Two-pronged heart-shaped forged weeding-hoe with wooden Mix handle  
Serfouette à coeur forgée bidente avec manche en bois Mix



COD. ART.	L mm	A mm	B mm	Gr.	BOX	COD. EAN - 13
130 ZCB MIX	1300	110	280	1050	6	80 3264633 178 3

Mercato / Markets / Marchés  

12 **Zappino a cuore bidente in acciaio forgiato con manico legno**

Two-pronged heart-shaped forged weeding-hoe with wooden handle  
Serfouette à coeur forgée bidente avec manche en bois

COD. ART.	L mm	A mm	B mm	Gr.	BOX	COD. EAN - 13
130 ZCB LE	1300	110	280	1050	6	80 5773372 286 2

Mercato / Markets / Marchés  

MARTELLERIA	4
MAZZE e PICCONI	20
SCALPELLI e LEVERINI	24
ARTICOLI PER PIETRA	26
SECCHI, CAZZUOLE, SPATOLE e VARIE	27
BADILI, PALE, RASCHIETTI e RASCHIAFANGO	39
ACCETTE, PICOZZINI, RONCOLE e MACETE	52
ASCE, MAZZESCURI e CUNEI	55
RASTRELLI, SARCHIATORI e AERATORI	61
SCOPE FOGLIE	69
RACCOLTA FRUTTA e TRATTAMENTO	78
NOVITÀ	84
FORCHE e VANGHE	90
<b>ZAPPE, ZAPPINI, ATTREZZINI e FORBICI</b>	<b>94</b>
MANICI FIBRA	101
MANICI MIX e LEGNO	115
ASTE TELESCOPICHE	123
ESPOSITORI	124
GUANTI	126
SOLLEVAMENTO e ANCORAGGIO	140

- 4 MARTELLERIA
- 20 MAZZE e PICCONI
- 24 SCALPELLI e LEVERINI
- 26 ARTICOLI PER PIETRA
- 27 SECCHI, CAZZUOLE, SPATOLE e VARIE
- 39 BADILI, PALE, RASCHIETTI e RASCHIAFANGO
- 52 ACCETTE, PICOZZINI, RONCOLE e MACETE
- 55 ASCE, MAZZESCURI e CUNEI
- 61 RASTRELLI, SARCHIATORI e AERATORI
- 69 SCOPE FOGLIE
- 78 RACCOLTA FRUTTA e TRATTAMENTO
- 84 NOVITÀ
- 90 FORCHE e VANGHE
- 94 **ZAPPE, ZAPPINI, ATTREZZINI e FORBICI**
- 101 MANICI FIBRA
- 115 MANICI MIX e LEGNO
- 123 ASTE TELESCOPICHE
- 124 ESPOSITORI
- 126 GUANTI
- 140 SOLLEVAMENTO e ANCORAGGIO



### 1 | Zappa tipo "Olbia" con manico in legno Mix

Forged square "Olbia" hoe with wooden Mix handle  
Houe carrée forgée modèle "Olbia" avec manche en bois Mix

COD. ART.	L mm	A mm	B mm	Gr.	BOX	COD. EAN - 13
140 Z06 MIX	1400	150	120	650	6	80 5773372 031 8
Mercato / Markets / Marchés						

### 2 | Zappa tipo "Olbia" con manico in legno

Forged square "Olbia" hoe with wooden handle  
Houe carrée forgée modèle "Olbia" avec manche en bois

COD. ART.	L mm	A mm	B mm	Gr.	BOX	COD. EAN - 13
140 Z06 LE	1400	150	120	650	6	80 5773372 032 5
Mercato / Markets / Marchés						

### 3 | Marra Sarda con manico in legno

Square eyed "Marra Sarda" hoe with wooden handle  
Houe douille carrée modèle "Marra Sarda" avec manche en bois

COD. ART.	L mm	A mm	B mm	Gr.	BOX	COD. EAN - 13
MARRA25 LE	1300	250	245	700	6	80 5773372 033 2
MARRA30 LE	1300	300	245	800	6	80 5773372 034 9
Mercato / Markets / Marchés						

### 4 | Zappa bidente "Campidano" con manico in legno Mix

Two-pronged forged "Campidano" hoe with wooden Mix handle  
Houe carrée bidente forgée modèle "Campidano" avec manche en bois Mix

COD. ART.	L mm	A mm	B mm	Gr.	BOX	COD. EAN - 13
140 ZQB10 MIX	1400	95	160	1000	6	80 5773372 029 5
Mercato / Markets / Marchés						

### 5 | Zappa bidente "Campidano" con manico in legno

Two-pronged forged "Campidano" hoe with wooden handle  
Houe carrée bidente forgée modèle "Campidano" avec manche en bois

COD. ART.	L mm	A mm	B mm	Gr.	BOX	COD. EAN - 13
140 ZQB10 LE	1400	95	160	1000	6	80 5773372 030 1
Mercato / Markets / Marchés						





### Zappa quadrata in acciaio forgiato

Forged steel square hoe  
Houe carrée en acier forgé

COD. ART.	A mm	B mm	Gr.	BOX	COD. EAN - 13
ZQ4	75	125	400	6	80 3264633 569 9
ZQ6	105	155	600	6	80 3264633 570 5
ZQ	120	190	800	6	80 3264633 993 2
ZQ10	140	205	1000	6	80 3264633 571 2

Mercato / Markets / Marchés  



### Zappa triangolare in acciaio forgiato

Forged steel triangular hoe  
Houe triangulaire en acier forgé

COD. ART.	A mm	B mm	Gr.	BOX	COD. EAN - 13
ZT	190	190	600	6	80 3264633 997 0
ZT8	220	220	800	6	80 3264633 572 9
ZT10	240	240	1000	6	80 3264633 573 6

Mercato / Markets / Marchés  



### Zappa tipo "Olbia" in acciaio forgiato

Forged still square "Olbia" hoe  
Houe carrée modèle "Olbia" en acier forgé

COD. ART.	A mm	B mm	Gr.	BOX	COD. EAN - 13
ZO6	150	120	650	6	80 3264633 564 4

Mercato / Markets / Marchés 



### Marra Sarda

Square eyed "Marra Sarda" hoe  
Houe douille carrée modèle "Marra Sarda"

COD. ART.	A mm	B mm	Gr.	BOX	COD. EAN - 13
MARRA25	250	145	700	6	80 3264633 523 1
MARRA30	300	145	800	6	80 3264633 524 8

Mercato / Markets / Marchés 



### Zappa bidente "Campidano" in acciaio forgiato

Two-pronged forged steel "Campidano" hoe  
Houe carrée bidente en acier forgé modèle "Campidano"

COD. ART.	A mm	B mm	Gr.	BOX	COD. EAN - 13
ZQB 10	95	160	1000	6	80 3264633 574 3

Mercato / Markets / Marchés  



### Zappino quadrato bidente in acciaio forgiato

Two-pronged square forged weeding-hoe  
Serfouette carrée forgée bidente

COD. ART.	A mm	B mm	Gr.	BOX	COD. EAN - 13
ZQB	80	280	490	6	80 3264633 123 3

Mercato / Markets / Marchés  



### Zappino a cuore bidente in acciaio forgiato

Two-pronged heart-shaped forged weeding-hoe  
Serfouette à coeur forgée bidente

COD. ART.	A mm	B mm	Gr.	BOX	COD. EAN - 13
ZCB	110	280	490	6	80 3264633 179 0

Mercato / Markets / Marchés  

MARTELLERIA 4

MAZZE e PICCONI 20

SCALPELLI e LEVERINI 24

ARTICOLI PER PIETRA 26

SECCHI, CAZZUOLE, SPATOLE e VARIE 27

BADILI, PALE, RASCHIETTI e RASCHIAFANGO 39

ACCETTE, PICOZZINI, RONCOLE e MACETE 52

ASCE, MAZZESCURI e CUNEI 55

RASTRELLI, SARCHIATORI e AERATORI 61

SCOPE FOGLIE 69

RACCOLTA FRUTTA e TRATTAMENTO 78

NOVITÀ 84

FORCHE e VANGHE 90

ZAPPE, ZAPPINI, ATTREZZINI e FORBICI 94

MANICI FIBRA 101

MANICI MIX e LEGNO 115

ASTE TELESCOPICHE 123

ESPOSITORI 124

GUANTI 126

SOLLEVAMENTO e ANCORAGGIO 140

4 MARTELLERIA  
20 MAZZE e PICCONI  
24 SCALPELLI e LEVERINI  
26 ARTICOLI PER PIETRA  
27 SECCHI, CAZZUOLE, SPATOLE e VARIE  
39 BADILI, PALE, RASCHIETTI e RASCHIAFANGO  
52 ACCETTE, PICOZZINI, RONCOLE e MACETE  
55 ASCE, MAZZESCURI e CUNEI  
61 RASTRELLI, SARCHIATORI e AERATORI  
69 SCOPE FOGLIE  
78 RACCOLTA FRUTTA e TRATTAMENTO  
84 NOVITÀ  
90 FORCHE e VANGHE  
94 ZAPPE, ZAPPINI, ATTREZZINI e FORBICI  
101 MANICI FIBRA  
115 MANICI MIX e LEGNO  
123 ASTE TELESCOPICHE  
124 ESPOSITORI  
126 GUANTI  
140 SOLLEVAMENTO e ANCORAGGIO



### Trapiantatore largo con manico gomma

Wide gardening paddle with rubber handle  
Large palette de jardinage avec manche en caoutchouc

COD. ART.	Gr.	L mm	BOX	COD. EAN - 13
MN01P	280	330	6	8 05773372 583 2
Mercato / Markets / Marchés				



### Piantatore con manico gomma

Planter with rubber handle  
Planteur avec manche en caoutchouc

COD. ART.	Gr.	L mm	BOX	COD. EAN - 13
MN07P	190	280	6	8 05773372 590 0
Mercato / Markets / Marchés				



### Trapiantatore stretto con manico gomma

Narrow gardening paddle with rubber handle  
Palette de jardinage étroit avec manche en caoutchouc

COD. ART.	Gr.	L mm	BOX	COD. EAN - 13
MN02P	290	330	6	8 05773372 584 9
Mercato / Markets / Marchés				



### Sarchiatore a lama con manico gomma

Blade weeder with rubber handle  
Désherbeur à lame avec manche en caoutchouc

COD. ART.	Gr.	L mm	BOX	COD. EAN - 13
MN09P	300	310	6	8 05773372 587 0
Mercato / Markets / Marchés				



### Rastrellino sei denti manico gomma

Small rake six teeth with rubber handle  
Petit râteau six dents avec manche en caoutchouc

COD. ART.	Gr.	L mm	BOX	COD. EAN - 13
MN04P	200	310	6	8 05773372 585 6
Mercato / Markets / Marchés				



### Scopetta con manico gomma

Small rake with rubber handle  
Petit balai avec manche en caoutchouc

COD. ART.	Gr.	L mm	BOX	COD. EAN - 13
MN10P	230	400	6	8 05773372 588 7
Mercato / Markets / Marchés				



### Coltivatore a tre denti manico gomma

Three-pronged rake with rubber handle  
Râteau à trois dents avec manche en caoutchouc

COD. ART.	Gr.	L mm	BOX	COD. EAN - 13
MN05P	270	310	6	8 05773372 586 3
Mercato / Markets / Marchés				



### Zappetta quadra/corna con manico gomma

Small square shaped/pronged hoe with rubber handle  
Serfouette carrée/fourche avec manche en caoutchouc



COD. ART.	Gr.	L mm	BOX	COD. EAN - 13
MN13P	320	310	6	8 05773372 589 4
Mercato / Markets / Marchés				



NEW

### Trapiantatore largo con manico in legno

Wide gardening paddle with wooden handle  
Large palette de jardinage avec manche en bois



COD. ART.	Gr.	L mm	BOX	COD. EAN - 13
MN01	210	320	6	80 5773372 252 7
Mercato / Markets / Marchés  				



NEW

### Trapiantatore stretto con manico in legno

Narrow gardening paddle with wooden handle  
Palette de jardinage étroite avec manche en bois



COD. ART.	Gr.	L mm	BOX	COD. EAN - 13
MN02	130	280	6	80 5773372 253 4
Mercato / Markets / Marchés  				



NEW

### Rastrellino a sei denti con manico in legno

Small rake six teeth with wooden handle  
Petit râtelier six dents avec manche en bois



COD. ART.	Gr.	L mm	BOX	COD. EAN - 13
MN04	220	330	6	80 5773372 254 1
Mercato / Markets / Marchés  				



NEW

### Coltivatore a tre denti con manico in legno

Three-pronged rake with wooden handle  
Râtelier à trois dents avec manche en bois



COD. ART.	Gr.	L mm	BOX	COD. EAN - 13
MN05	210	350	6	80 5773372 255 8
Mercato / Markets / Marchés  				



NEW

### Piantatore con manico in legno

Planter with wooden handle  
Planteur avec manche en bois



COD. ART.	Gr.	L mm	BOX	COD. EAN - 13
MN07	110	250	6	80 5773372 256 5
Mercato / Markets / Marchés  				



NEW

### Sarchiatore a lama con manico in legno

Blade weeder with wooden handle  
Désherbeur à lame avec manche en bois

COD. ART.	Gr.	L mm	BOX	COD. EAN - 13
MN09	200	350	6	80 5773372 257 2
Mercato / Markets / Marchés  				

MARTELLERIA	4
MAZZE e PICCONI	20
SCALPELLI e LEVERINI	24
ARTICOLI PER PIETRA	26
SECCHI, CAZZUOLE, SPATOLE e VARIE	27
BADILI, PALE, RASCHIETTI e RASCHIAFANGO	39
ACCETTE, PICOZZINI, RONCOLE e MACETE	52
ASCE, MAZZESCURI e CUNEI	55
RASTRELLI, SARCHIATORI e AERATORI	61
SCOPE FOGLIE	69
RACCOLTA FRUTTA e TRATTAMENTO	78
NOVITÀ	84
FORCHE e VANGHE	90
ZAPPE, ZAPPINI, ATTREZZINI e FORBICI	94
MANICI FIBRA	101
MANICI MIX e LEGNO	115
ASTE TELESCOPICHE	123
ESPOSITORI	124
GUANTI	126
SOLLEVAMENTO e ANCORAGGIO	140

- 4 MARTELLERIA
- 20 MAZZE e PICCONI
- 24 SCALPELLI e LEVERINI
- 26 ARTICOLI PER PIETRA
- 27 SECCHI, CAZZUOLE, SPATOLE e VARIE
- 39 BADILI, PALE, RASCHIETTI e RASCHIAFANGO
- 52 ACCETTE, PICOZZINI, RONCOLE e MACETE
- 55 ASCE, MAZZESCURI e CUNEI
- 61 RASTRELLI, SARCHIATORI e AERATORI
- 69 SCOPE FOGLIE
- 78 RACCOLTA FRUTTA e TRATTAMENTO
- 84 NOVITÀ
- 90 FORCHE e VANGHE
- 94 ZAPPE, ZAPPINI, ATTREZZINI e FORBICI
- 101 MANICI FIBRA
- 115 MANICI MIX e LEGNO
- 123 ASTE TELESCOPICHE
- 124 ESPOSITORI
- 126 GUANTI
- 140 SOLLEVAMENTO e ANCORAGGIO

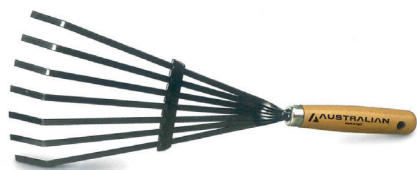

**NEW** Scopetta con manico in legno  
Small rake with wooden handle  
Petit balai avec manche en bois

COD. ART.	Gr.	L mm	BOX	COD. EAN - 13
MN10	230	400	6	80 5773372 258 9
Mercato / Markets / Marchés				



**NEW** Zappetta quadra/cuore con manico in legno  
Small square/heart shaped hoe with wooden handle  
Petite serfouette carrée/à coeur avec manche en bois

COD. ART.	Gr.	L mm	BOX	COD. EAN - 13
MN12	270	400	6	80 5773372 259 6
Mercato / Markets / Marchés				



**NEW** Zappetta quadra/corna con manico in legno  
Small square shaped/pronged hoe with wooden handle  
Serfouette carrée/fourche avec manche en bois

COD. ART.	Gr.	L mm	BOX	COD. EAN - 13
MN13	270	400	6	80 5773372 260 2
Mercato / Markets / Marchés				



**Forbici INOX cm19**

INOX shears cm 19  
Ciseaux INOX cm 19

COD. ART.	Gr.	L mm	COD. EAN - 13
FU19I	120	190	80 3264633 613 9
Mercato / Markets / Marchés			



**Forbici Cogliuva lama dritta cm19**

Grape scissors straight blade cm 19  
Ciseaux à raisins lame droite cm 19

COD. ART.	Gr.	L mm	COD. EAN - 13
FU19SD	120	190	80 3264633 614 6
Mercato / Markets / Marchés			

## Manici in fibra di vetro

Struttura prodotto

I manici di questa famiglia sono costituiti da un corpo in vetroresina tubolare, estremamente sottile e resistente, da un lato chiuso con un elemento in polipropilene elastico di forma conica e dall'altro lato chiuso da un tappo posticcio realizzato anch'esso in plastica, al cui interno è ricavato il foro per appenderlo.

Handles belonging to this family are composed by a tubular fiberglass body extremely thin and resistant, closed on one side by an elastic polypropylene element with a conic shape. On the other side it's closed by a false plug realized in plastic, in which there is a hole for the hanging.

Les manches qui font partie de cette famille sont composés par un corp tubulaire en fibre de verre extrêmement mince et résistant, fermé à un coté par un élément en polypropylène élastique avec forme conique. A l'autre coté il est fermé par un bouchon faux réalisé aussi en plastique, avec un trou pour le pendre.



## Manico ultraleggero per badili e forche

Ultralight fiberglass handle for shovels and pitchforks  
Manche ultraleger en fibre de verre pour pelles et fourches

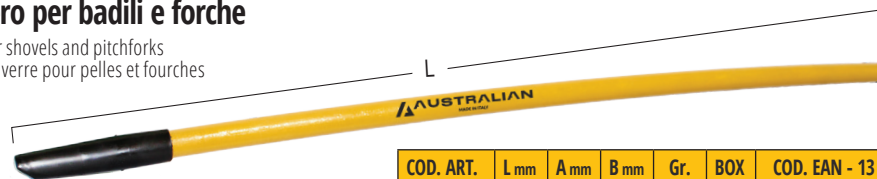

COD. ART.	L mm	A mm	B mm	Gr.	BOX	COD. EAN - 13
1130 BP	1300	28	40	720	20	80 3264633 723 5
1140 BP	1400	28	40	720	20	80 3264633 724 2
Mercato / Markets / Marchés						

MARTELLERIA	4
MAZZE e PICCONI	20
SCALPELLI e LEVERINI	24
ARTICOLI PER PIETRA	26
SECCHI, CAZZUOLE, SPATOLE e VARIE	27
BADILI, PALE, RASCHIETTI e RASCHIAFANGO	39
ACCETTE, PICOZZINI, RONCOLE e MACETE	52
ASCE, MAZZESCURI e CUNEI	55
RASTRELLI, SARCHIATORI e AERATORI	61
SCOPE FOGLIE	69
RACCOLTA FRUTTA e TRATTAMENTO	78
NOVITÀ	84
FORCHE e VANGHE	90
ZAPPE, ZAPPINI, ATTREZZINI e FORBICI	94
<b>MANICI FIBRA</b>	<b>101</b>
MANICI MIX e LEGNO	115
ASTE TELESCOPICHE	123
ESPOSITORI	124
GUANTI	126
SOLLEVAMENTO e ANCORAGGIO	140

- 4 MARTELLERIA
- 20 MAZZE e PICCONI
- 24 SCALPELLI e LEVERINI
- 26 ARTICOLI PER PIETRA
- 27 SECCHI, CAZZUOLE, SPATOLE e VARIE
- 39 BADILI, PALE, RASCHIETTI e RASCHIAFANGO
- 52 ACCETTE, PICOZZINI, RONCOLE e MACETE
- 55 ASCE, MAZZESCURI e CUNEI
- 61 RASTRELLI, SARCHIATORI e AERATORI
- 69 SCOPE FOGLIE
- 78 RACCOLTA FRUTTA e TRATTAMENTO
- 84 NOVITÀ
- 90 FORCHE e VANGHE
- 94 ZAPPE, ZAPPINI, ATTREZZINI e FORBICI
- 101 MANICI FIBRA**
- 115 MANICI MIX e LEGNO
- 123 ASTE TELESCOPICHE
- 124 ESPOSITORI
- 126 GUANTI
- 140 SOLLEVAMENTO e ANCORAGGIO

### Manico ultraleggero per vanghe

Ultralight fiberglass handle for spades  
Manche ultraleger en fibre de verre pour bèches



COD. ART.	L mm	A mm	B mm	Gr.	BOX	COD. EAN - 13
1130 VP	1300	28	40	660	20	80 3264633 726 6
1140 VP	1400	28	40	700	20	80 3264633 727 3

Mercato / Markets / Marchés

### Manico ultraleggero per badile a collo di cigno

Ultralight fiberglass handle for swan neck showels  
Manche ultraleger en fibre de verre pour pelles à col de cygne



COD. ART.	L mm	A mm	B mm	Gr.	BOX	COD. EAN - 13
1110 VP	1100	28	40	580	20	80 3264633 725 9

Mercato / Markets / Marchés

### Manico a "T" ultraleggero

Ultralight "T" shaped fiberglass handle  
Manche ultraleger en fibre de verre béquille en "T"



COD. ART.	L mm	A mm	B mm	Gr.	BOX	COD. EAN - 13
T750 BD P	750	28	40	630	15	80 3264633 728 0
T900 BD P	900	28	40	700	15	80 3264633 729 7
T1100 BD P	1100	28	40	780	15	80 3264633 730 3

Mercato / Markets / Marchés

### Manico a "D" ultraleggero

Ultralight "D" shaped fiberglass handle  
Manche ultraleger en fibre de verre béquille en "D"



COD. ART.	L mm	A mm	B mm	Gr.	BOX	COD. EAN - 13
D900B DP	900	28	40	650	15	80 5773372 723 2

Mercato / Markets / Marchés

### Manico ultraleggero per rastrelli – scope

Ultralight fiberglass handle for rakes and brooms  
Manche ultraleger en fibre de verre pour râtaeux, balai et outils douilles

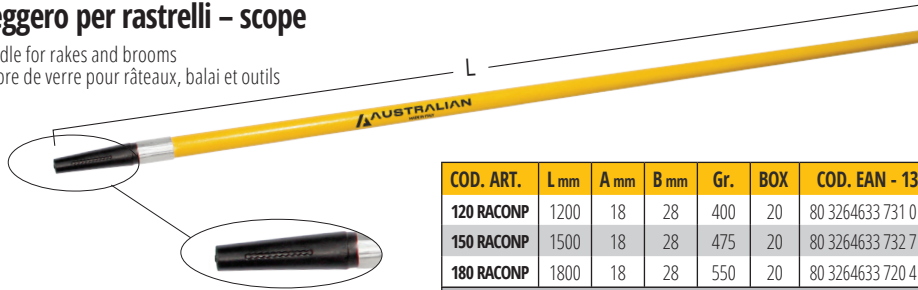

COD. ART.	L mm	A mm	B mm	Gr.	BOX	COD. EAN - 13
120 RACONP	1200	18	28	400	20	80 3264633 731 0
150 RACONP	1500	18	28	475	20	80 3264633 732 7
180 RACONP	1800	18	28	550	20	80 3264633 720 4

Mercato / Markets / Marchés

### Manico ultraleggero per rastrelli – scope con filettatura

Ultralight fiberglass handle for rakes and brooms with screw thread  
Manche ultraleger en fibre de verre pour râtaeux, balai et outils douilles avec filetage

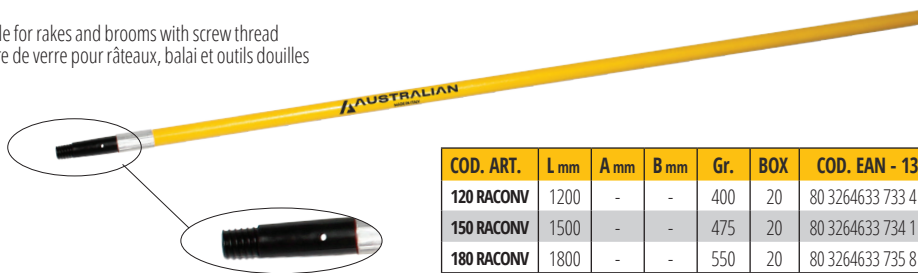

COD. ART.	L mm	A mm	B mm	Gr.	BOX	COD. EAN - 13
120 RACONV	1200	-	-	400	20	80 3264633 733 4
150 RACONV	1500	-	-	475	20	80 3264633 734 1
180 RACONV	1800	-	-	550	20	80 3264633 735 8

Mercato / Markets / Marchés

### Manico ultraleggero per rastrelli – scope con filettatura francese

Ultralight fiberglass handle for rakes and brooms with french screw thread  
Manche ultraleger en fibre de verre pour râtaeux, balai et outils douilles avec filetage française

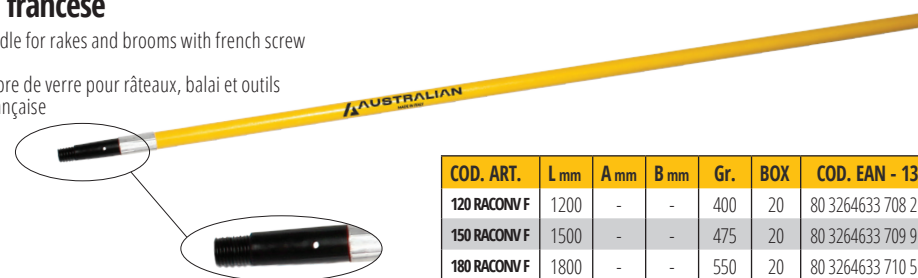

COD. ART.	L mm	A mm	B mm	Gr.	BOX	COD. EAN - 13
120 RACONV F	1200	-	-	400	20	80 3264633 708 2
150 RACONV F	1500	-	-	475	20	80 3264633 709 9
180 RACONV F	1800	-	-	550	20	80 3264633 710 5

Mercato / Markets / Marchés

MARTELLERIA	4
MAZZE e PICCONI	20
SCALPELLI e LEVERINI	24
ARTICOLI PER PIETRA	26
SECCHI, CAZZUOLE, SPATOLE e VARIE	27
BADILI, PALE, RASCHIETTI e RASCHIAFANGO	39
ACCETTE, PICOZZINI, RONCOLE e MACETE	52
ASCE, MAZZESCURI e CUNEI	55
RASTRELLI, SARCHIATORI e AERATORI	61
SCOPE FOGLIE	69
RACCOLTA FRUTTA e TRATTAMENTO	78
NOVITÀ	84
FORCHE e VANGHE	90
ZAPPE, ZAPPINI, ATTREZZINI e FORBICI	94
<b>MANICI FIBRA</b>	<b>101</b>
MANICI MIX e LEGNO	115
ASTE TELESCOPICHE	123
ESPOSITORI	124
GUANTI	126
SOLLEVAMENTO e ANCORAGGIO	140

- 4 MARTELLERIA
- 20 MAZZE e PICCONI
- 24 SCALPELLI e LEVERINI
- 26 ARTICOLI PER PIETRA
- 27 SECCHI, CAZZUOLE, SPATOLE e VARIE
- 39 BADILI, PALE, RASCHIETTI e RASCHIAFANGO
- 52 ACCETTE, PICOZZINI, RONCOLE e MACETE
- 55 ASCE, MAZZESCURI e CUNEI
- 61 RASTRELLI, SARCHIATORI e AERATORI
- 69 SCOPE FOGLIE
- 78 RACCOLTA FRUTTA e TRATTAMENTO
- 84 NOVITÀ
- 90 FORCHE e VANGHE
- 94 ZAPPE, ZAPPINI, ATTREZZINI e FORBICI
- 101 MANICI FIBRA**
- 115 MANICI MIX e LEGNO
- 123 ASTE TELESCOPICHE
- 124 ESPOSITORI
- 126 GUANTI
- 140 SOLLEVAMENTO e ANCORAGGIO

### Manico per zappino ultraleggero Ø 28 in fibra di vetro

Ultralight fiberglass handle for weeding hoe-eye Ø 28  
 Manche de houe et serfouette ultraleger en fibre de verre Ø 28



COD. ART.	L mm	A mm	B mm	Gr.	BOX	COD. EAN - 13
<b>28120 ZP</b>	1200	28	28	390	20	80 3264633 736 5
<b>28130 ZP</b>	1300	28	28	400	20	80 3264633 737 2

Mercato / Markets / Marchés



### Manico per zappino ultraleggero Ø 30 in fibra di vetro

Ultralight fiberglass handle for weeding hoe-eye Ø 30  
 Manche de houe et serfouette ultraleger en fibre de verre Ø 30



COD. ART.	L mm	A mm	B mm	Gr.	BOX	COD. EAN - 13
<b>30120 ZP</b>	1200	30	30	400	20	80 3264633 738 9
<b>30130 ZP</b>	1300	30	30	415	20	80 3264633 739 6

Mercato / Markets / Marchés



### Manico per zappa tondo ultraleggero Ø 35 in fibra di vetro

Ultralight fiberglass handle for hoe-round eye Ø 35  
 Manche de houe et serfouette ultraleger en fibre de verre Ø 35



COD. ART.	L mm	A mm	B mm	Gr.	BOX	COD. EAN - 13
<b>35120 ZP</b>	1200	35	35	630	20	80 3264633 740 2
<b>35140 ZP</b>	1400	35	35	730	20	80 3264633 741 9

Mercato / Markets / Marchés



### Manico per zappa tondo ultraleggero Ø 40 in fibra di vetro

Ultralight fiberglass handle for hoe-round eye Ø 40  
 Manche de houe et serfouette ultraleger en fibre de verre Ø 40



COD. ART.	L mm	A mm	B mm	Gr.	BOX	COD. EAN - 13
<b>40120 ZP</b>	1200	40	40	650	20	80 3264633 742 6
<b>40140 ZP</b>	1400	40	40	750	20	80 3264633 743 3

Mercato / Markets / Marchés





## Manici in resina

Struttura prodotto

Questa nostra produzione é interamente realizzata in nylon modificato con fibre di vetro che conferisce ai manici altissima resistenza. La tecnologia utilizzata ci consente di ottenere prodotti svuotati grazie all'utilizzo di particolari presse a gas, con cui ci è possibile togliere materiale dall'interno dei manici.

I materiali utilizzati rendono i nostri prodotti estremamente leggeri e affidabili e comunemente molto più resistenti di quelli in legno, ideali quindi per uso professionale.

We have carried out our production using nylon modified by glass fibres which grant strong resistance to handles. Special kinds of gas presses allow us to remove material from the internal part of the handles so that we manage to obtain emptied products.

The materials used grant lightness and reliability to our products.

Moreover, they are more resistant than the wooden ones; therefore excellent for professional use.

Notre production est réalisée en nylon modifié avec fibres de verre qui donnent aux manches une très haute résistance. La technologie employée nous permet d'obtenir des produits creux grâce à l'utilisation de presses particulières à gaz avec lesquelles il est possible d'enlever du matériel à l'intérieur des manches.

Les matériaux employés rendent nos produits extrêmement légers et fiables et beaucoup plus résistants que ceux en bois et ils sont, donc, idéaux pour l'usage professionnel.



**ISOLANTE  
INDEFORMABILE  
ANALLERGICO**

### Manico a "T" in resina (impugnatura in gomma)

"T" shaped resin handle (rubber haft)  
Manche injectés à gas en résine bequille en "T"



COD. ART.	L mm	A mm	B mm	BOX	COD. EAN - 13
1095 TVG	950	30	40	15	80 3264633 744 0
1100 TVG	1100	30	40	15	80 3264633 745 7

Mercato / Markets / Marchés

### Manico a "T" in resina (impugnatura in gomma curvo)

"T" shaped resin handle (rubber haft)  
Manche injectés à gas en résine bequille en "T"

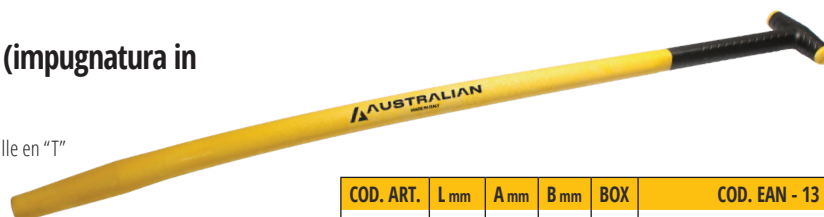

COD. ART.	L mm	A mm	B mm	BOX	COD. EAN - 13
1095 TBG	950	30	40	15	80 3264633 746 4
1100 TBG	1100	30	40	15	80 3264633 747 1

Mercato / Markets / Marchés

MARTELLERIA	4
MAZZE e PICCONI	20
SCALPELLI e LEVERINI	24
ARTICOLI PER PIETRA	26
SECCHI, CAZZUOLE, SPATOLE e VARIE	27
BADILI, PALE, RASCHIETTI e RASCHIAFANGO	39
ACCETTE, PICOZZINI, RONCOLE e MACETE	52
ASCE, MAZZESCURI e CUNEI	55
RASTRELLI, SARCHIATORI e AERATORI	61
SCOPE FOGLIE	69
RACCOLTA FRUTTA e TRATTAMENTO	78
NOVITÀ	84
FORCHE e VANGHE	90
ZAPPE, ZAPPINI, ATTREZZINI e FORBICI	94
<b>MANICI FIBRA</b>	<b>101</b>
MANICI MIX e LEGNO	115
ASTE TELESCOPICHE	123
ESPOSITORI	124
GUANTI	126
SOLLEVAMENTO e ANCORAGGIO	140

4 MARTELLERIA  
20 MAZZE e PICCONI  
24 SCALPELLI e LEVERINI  
26 ARTICOLI PER PIETRA  
27 SECCHI, CAZZUOLE, SPATOLE e VARIE  
39 BADILI, PALE, RASCHIETTI e RASCHIAFANGO  
52 ACCETTE, PICOZZINI, RONCOLE e MACETE  
55 ASCE, MAZZESCURI e CUNEI  
61 RASTRELLI, SARCHIATORI e AERATORI  
69 SCOPE FOGLIE  
78 RACCOLTA FRUTTA e TRATTAMENTO  
84 NOVITÀ  
90 FORCHE e VANGHE  
94 ZAPPE, ZAPPINI, ATTREZZINI e FORBICI  
**101 MANICI FIBRA**  
115 MANICI MIX e LEGNO  
123 ASTE TELESCOPICHE  
124 ESPOSITORI  
126 GUANTI  
140 SOLLEVAMENTO e ANCORAGGIO

### Manico resina per badili - forche

Resin handle for shovels  
Manche résine pour pelles



COD. ART.	L mm	A mm	B mm	BOX	COD. EAN - 13
<b>1150 B</b>	1500	30	40	20	80 3264633 312 1
<b>1140 B</b>	1400	30	40	20	80 3264633 001 4
<b>1135 B</b>	1350	30	40	20	80 3264633 002 1

Mercato / Markets / Marchés

### Manico resina per vanghe

Resin handle for spades  
Manche résine pour bêches



COD. ART.	L mm	A mm	B mm	BOX	COD. EAN - 13
<b>1150 V</b>	1500	30	40	20	80 3264633 313 8
<b>1140 V</b>	1400	30	40	20	80 3264633 003 8
<b>1135 V</b>	1350	30	40	20	80 3264633 004 5
<b>1115 V</b>	1150	30	40	20	80 3264633 000 7

Mercato / Markets / Marchés

### Manico resina per badile Svizzera

Resin handle for Helvetic shovel  
Manche résine pour pelle Suisse



COD. ART.	L mm	A mm	B mm	BOX	COD. EAN - 13
<b>1140 BS</b>	1400	30	40	20	80 3264633 478 4

Mercato / Markets / Marchés

### Manico resina per rastrelli - scope

Resin handle for rakes and brooms  
Manche résine pour râtaux, balai et outils douilles



COD. ART.	L mm	A mm	B mm	BOX	COD. EAN - 13
<b>150 RACON</b>	1500	18	28	20	80 3264633 005 2
<b>125 RACON</b>	1250	18	28	20	80 3264633 006 9
<b>110 RACON</b>	1100	18	28	20	80 3264633 202 5

Mercato / Markets / Marchés

## Manici in fibra di vetro

Struttura prodotto

Questa linea di prodotti ha la particolarità di unire la rigidità della fibra di vetro alla plasticità del polipropilene. Il prodotto viene realizzato costampando il polipropilene intorno alla fibra di vetro, così facendo si ottiene un manico per utensili estremamente resistente e ideale per uso professionale. Tutti i nostri prodotti sono garantiti e sono espressione di quei valori che da sempre ci contraddistinguono: Serietà e Innovazione.

This product line has the peculiarity of combining the stiffness of the glass fibre with the malleability of the polypropylene. The product is realised impressing polypropylene all around the glass fibre, so that the tool handle is extremely resistant and ideal for professional use. Our products are guaranteed and are expression of those values that have always distinguished us: Reliability and Innovation.

Cette ligne de produits a la particularité de réunir la rigidité de la fibre de verre à la plasticité du polypropylène. Le produit est réalisé imprimant en même temps le polypropylène autour de la fibre de verre; ainsi on obtient un manche pour outils extrêmement résistant et idéal pour usage professionnel. Tous nos produits sont garantis et ils sont l'expression des valeurs qui depuis longtemps nous distinguent: conscience professionnelle et Innovation.



**FLESSIBILE  
ISOLANTE  
INDEFORMABILE  
ANALLERGICO**

MARTELLERIA	4
MAZZE e PICCONI	20
SCALPELLI e LEVERINI	24
ARTICOLI PER PIETRA	26
SECCHI, CAZZUOLE, SPATOLE e VARIE	27
BADILI, PALE, RASCHIETTI e RASCHIAFANGO	39
ACCETTE, PICOZZINI, RONCOLE e MACETE	52
ASCE, MAZZESCURI e CUNEI	55
RASTRELLI, SARCHIATORI e AERATORI	61
SCOPE FOGLIE	69
RACCOLTA FRUTTA e TRATTAMENTO	78
NOVITÀ	84
FORCHE e VANGHE	90
ZAPPE, ZAPPINI, ATTREZZINI e FORBICI	94
<b>MANICI FIBRA</b>	<b>101</b>
MANICI MIX e LEGNO	115
ASTE TELESCOPICHE	123
ESPOSITORI	124
GUANTI	126
SOLLEVAMENTO e ANCORAGGIO	140

4 MARTELLERIA  
20 MAZZE e PICCONI  
24 SCALPELLI e LEVERINI  
26 ARTICOLI PER PIETRA  
27 SECCHI, CAZZUOLE, SPATOLE e VARIE  
39 BADILI, PALE, RASCHIETTI e RASCHIAFANGO  
52 ACCETTE, PICOZZINI, RONCOLE e MACETE  
55 ASCE, MAZZESCURI e CUNEI  
61 RASTRELLI, SARCHIATORI e AERATORI  
69 SCOPE FOGLIE  
78 RACCOLTA FRUTTA e TRATTAMENTO  
84 NOVITÀ  
90 FORCHE e VANGHE  
94 ZAPPE, ZAPPINI, ATTREZZINI e FORBICI  
**101 MANICI FIBRA**  
115 MANICI MIX e LEGNO  
123 ASTE TELESCOPICHE  
124 ESPOSITORI  
126 GUANTI  
140 SOLLEVAMENTO e ANCORAGGIO

### Manico anima fibra di vetro per pala a collo di cigno (impugnatura in gomma)

Fibreglass core handle (rubber haft) for swan neck shovel  
Manche trimatière pomme pour pelle à col de cygne louchets

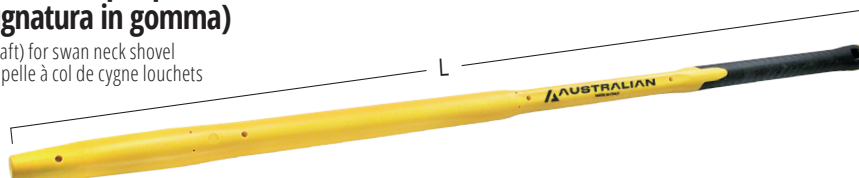

COD. ART.	L mm	A mm	B mm	BOX	COD. EAN - 13
<b>1100 BDG</b>	1100	24	38	20	80 3264633 149 3
<b>1100 BDG/F</b>	1100	26	38	20	80 5773372 371 5

Mercato / Markets / Marchés



### Manico anima fibra di vetro a "T" per vanga (impugnatura in gomma)

Fibreglass core "T" shaped handle (rubber haft) for spade  
Manche trimatière béquille en "T" pour bêche



COD. ART.	L mm	A mm	B mm	BOX	COD. EAN - 13
<b>T 900 BDG</b>	900	24	38	15	80 3264633 150 9
<b>T 900 BDG/F</b>	900	26	38	20	80 5773372 372 2

Mercato / Markets / Marchés



### Manico a "T" per vanga punta ridotta con anima in fibra di vetro (impugnatura in gomma)

"T" shaped reduced handle (rubber haft)  
Manche beche louchet bequille en "T"



COD. ART.	L mm	A mm	B mm	BOX	COD. EAN - 13
<b>T 750 BLG</b>	780	26	33	15	80 3264633 748 8
<b>T 900 BLG</b>	930	26	33	15	80 3264633 749 5
<b>T 1100 BLG</b>	1100	26	33	15	80 3264633 750 1

Mercato / Markets / Marchés



**Manico anima in fibra di vetro per piccone italiano occhio ovale (impugnatura in gomma)**

Fiberglass core italian type pickaxe handle with oval eye  
Manche trimatières pour pioche modèle italien avec oeil ovale



COD. ART.	L mm	A mm	B mm	BOX	COD. EAN - 13
4091/POG	910	55	40	20	80 3264633 065 6
4100/POG	1000	55	40	20	80 3264633 066 3

Mercato / Markets / Marchés

**Manico anima in fibra di vetro per piccone francese occhio tondo (impugnatura in gomma)**

Fiberglass core french type pickaxe handle with round eye  
Manche trimatières pour pioche modèle français avec oeil rond



COD. ART.	L mm	A mm	B mm	BOX	COD. EAN - 13
4091/PTG	910	48	48	20	80 3264633 067 0
4100/PTG	1000	48	48	20	80 3264633 068 7

Mercato / Markets / Marchés

**Manico anima in fibra di vetro per piccone francese occhio ovale (impugnatura in gomma)**

Fiberglass core french type pickaxe handle with oval eye  
Manche trimatières pour pioche modèle français avec oeil ovale



COD. ART.	L mm	A mm	B mm	BOX	COD. EAN - 13
4091/POFG	910	59	40	20	80 3264633 200 1

Mercato / Markets / Marchés

**Manico anima in fibra di vetro per piccone svizzero occhio ovale (impugnatura in gomma)**

Fiberglass core swiss type pickaxe handle with oval eye  
Manche trimatières pour pioche modèle suisse avec oeil ovale



COD. ART.	L mm	A mm	B mm	BOX	COD. EAN - 13
4091/POSG	910	65	42	20	80 3264633 479 1

Mercato / Markets / Marchés

MARTELLERIA 4

MAZZE e PICCONI 20

SCALPELLI e LEVERINI 24

ARTICOLI PER PIETRA 26

SECCHI, CAZZUOLE, SPATOLE e VARIE 27

BADILI, PALE, RASCHIETTI e RASCHIAFANGO 39

ACCETTE, PICOZZINI, RONCOLE e MACETE 52

ASCE, MAZZESCURI e CUNEI 55

RASTRELLI, SARCHIATORI e AERATORI 61

SCOPE FOGLIE 69

RACCOLTA FRUTTA e TRATTAMENTO 78

NOVITÀ 84

FORCHE e VANGHE 90

ZAPPE, ZAPPINI, ATTREZZINI e FORBICI 94

**MANICI FIBRA 101**

MANICI MIX e LEGNO 115

ASTE TELESCOPICHE 123

ESPOSITORI 124

GUANTI 126

SOLLEVAMENTO e ANCORAGGIO 140

- 4 MARTELLERIA
- 20 MAZZE e PICCONI
- 24 SCALPELLI e LEVERINI
- 26 ARTICOLI PER PIETRA
- 27 SECCHI, CAZZUOLE, SPATOLE e VARIE
- 39 BADILI, PALE, RASCHIETTI e RASCHIAFANGO
- 52 ACCETTE, PICOZZINI, RONCOLE e MACETE
- 55 ASCE, MAZZESCURI e CUNEI
- 61 RASTRELLI, SARCHIATORI e AERATORI
- 69 SCOPE FOGLIE
- 78 RACCOLTA FRUTTA e TRATTAMENTO
- 84 NOVITÀ
- 90 FORCHE e VANGHE
- 94 ZAPPE, ZAPPINI, ATTREZZINI e FORBICI
- 101 MANICI FIBRA**
- 115 MANICI MIX e LEGNO
- 123 ASTE TELESCOPICHE
- 124 ESPOSITORI
- 126 GUANTI
- 140 SOLLEVAMENTO e ANCORAGGIO

**Manico anima in fibra di vetro per piccone tedesco (impugnatura in gomma)**

Fiberglass core german type pickaxe handle with oval eye  
Manche trimatières pour pioche modèle allemand avec oeil ovale



COD. ART.	L mm	A mm	B mm	BOX	COD. EAN - 13
4091/PODG	910	74	43	20	80 3264633 480 7
4100/PODG	1000	74	43	20	80 3264633 481 4

Mercato / Markets / Marchés

**Manico anima in fibra di vetro per mazze/mazzescuri / asce (impugnatura in gomma)**

Fiberglass core handle (rubber haft) for sledgehammers/woodsplitting axes/cutting or splitting axes  
Manche trimatières pour masses /Merlin/haches



COD. ART.	L mm	A mm	B mm	BOX	COD. EAN - 13
4091/MG	910	49	32	20	80 3264633 069 4
4100/MG	1000	49	32	20	80 3264633 070 0
4071/MG	710	49	32	20	80 3264633 482 1

Mercato / Markets / Marchés

**Manico anima in fibra di vetro per asce italiane tipo "Rinaldi 302 n° 4 / 303 n°3-4 / 307 n° 3-4-5" (impugnatura in gomma)**

Fiberglass core handle (rubber haft) for Italian axes, "Rinaldi" model  
Manche trimatières pour haches italiennes, modèle Rinaldi



COD. ART.	L mm	A mm	B mm	BOX	COD. EAN - 13
4091/SG/RIN	910	51	30	20	80 3264633 236 0
4100/SG/RIN	1000	51	30	20	80 3264633 483 8
4071/SG/RIN	710	51	30	20	80 3264633 484 5

Mercato / Markets / Marchés

**Manico anima in fibra di vetro per accette tipo "Rinaldi" 302 n° 00-0" (impugnatura in gomma)**

Fiberglass core handle (rubber haft) for hatchet "Rinaldi" model  
Manche trimatières pour hachette italiennes modèle Rinaldi



COD. ART.	L mm	A mm	B mm	BOX	COD. EAN - 13
4045AG/RIN	450	42	25	20	80 3264633 235 3



Mercato / Markets / Marchés

**Manico anima in fibra di vetro per martello carpentiere / muratore / martellina (impugnatura in gomma)**

Fibreglass core handle (rubber haft) for carpenter's hammer / chipping hammer little pickaxe / mason's hammer  
Manche trimatière pour marteau charpentier modèle italien / décintrouir à hache / décintrouir à pic martelette à briques



COD. ART.	L mm	A mm	B mm	BOX	COD. EAN - 13
4040/CAG	400	36	27	20	80 3264633 174 5
4045/CAG	450	36	27	20	80 3264633 071 7
4050/CAG	500	36	27	20	80 3264633 072 4
4058/CAG	580	36	27	20	80 3264633 073 1



Mercato / Markets / Marchés  

**Manico anima in fibra di vetro per martello carpentiere "Bellota 400 gr. / Rinaldi 450 gr." (impugnatura in gomma)**

Fibreglass core handle (rubber haft) for carpenter's hammer  
Manche trimatières pour marteau de coffreur



COD. ART.	L mm	A mm	B mm	BOX	COD. EAN - 13
4045/CBG	450	37	28	20	80 3264633 485 2
4050/CBG	500	37	28	20	80 3264633 075 5



Mercato / Markets / Marchés  

**Manico anima in fibra di vetro per martello carpentiere "Bellota 250 gr. / Rinaldi 250 gr. / 350 gr." (impugnatura in gomma)**

Fibreglass core handle (rubber haft) for carpenter's hammer  
Manche trimatières pour marteau de coffreur



COD. ART.	L mm	A mm	B mm	BOX	COD. EAN - 13
4045/CRG/RIN	450	34	25	20	80 3264633 348 0
4050/CRG/RIN	500	34	25	20	80 3264633 351 0

Mercato / Markets / Marchés  

MARTELLERIA	4
MAZZE e PICCONI	20
SCALPELLI e LEVERINI	24
ARTICOLI PER PIETRA	26
SECCHI, CAZZUOLE, SPATOLE e VARIE	27
BADILI, PALE, RASCHIETTI e RASCHIAFANGO	39
ACCETTE, PICOZZINI, RONCOLE e MACETE	52
ASCE, MAZZESCURI e CUNEI	55
RASTRELLI, SARCHIATORI e AERATORI	61
SCOPE FOGLIE	69
RACCOLTA FRUTTA e TRATTAMENTO	78
NOVITÀ	84
FORCHE e VANGHE	90
ZAPPE, ZAPPINI, ATTREZZINI e FORBICI	94
<b>MANICI FIBRA</b>	<b>101</b>
MANICI MIX e LEGNO	115
ASTE TELESCOPICHE	123
ESPOSITORI	124
GUANTI	126
SOLLEVAMENTO e ANCORAGGIO	140

- 4 MARTELLERIA
- 20 MAZZE e PICCONI
- 24 SCALPELLI e LEVERINI
- 26 ARTICOLI PER PIETRA
- 27 SECCHI, CAZZUOLE, SPATOLE e VARIE
- 39 BADILI, PALE, RASCHIETTI e RASCHIAFANGO
- 52 ACCETTE, PICOZZINI, RONCOLE e MACETE
- 55 ASCE, MAZZESCURI e CUNEI
- 61 RASTRELLI, SARCHIATORI e AERATORI
- 69 SCOPE FOGLIE
- 78 RACCOLTA FRUTTA e TRATTAMENTO
- 84 NOVITÀ
- 90 FORCHE e VANGHE
- 94 ZAPPE, ZAPPINI, ATTREZZINI e FORBICI
- 101 MANICI FIBRA**
- 115 MANICI MIX e LEGNO
- 123 ASTE TELESCOPICHE
- 124 ESPOSITORI
- 126 GUANTI
- 140 SOLLEVAMENTO e ANCORAGGIO

**Manico anima in fibra di vetro per martello carpentiere francese "Coffreur" / accetta / accetta martello / gessatore (impugnatura in gomma)**

Fibreglass core handle (rubber haft) for French carp.hammer / hatchets  
 Manche trimatières pour marteau "Coffreur" / hachette / hachette à tête

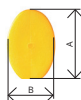

COD. ART.	L mm	A mm	B mm	BOX	COD. EAN - 13
<b>4037/FAG</b>	370	38	27	20	80 3264633 076 2
Mercato / Markets / Marchés					

**Manico anima in fibra di vetro per martello carpentiere greco "Skeparni" (impugnatura in gomma)**

Fibreglass core handle (rubber haft) for Greek carp.hammer "Skeparni"  
 Manche trimatières pour marteau de coffreur grec "Skeparni"



COD. ART.	L mm	A mm	B mm	BOX	COD. EAN - 13
<b>40 GR 38 G</b>	380	34	34	20	80 3264633 077 9
Mercato / Markets / Marchés					

**Manico anima in fibra di vetro per mazzetta antisfilamento (impugnatura in gomma)**

Fibreglass core handle (rubber haft) for anti-unthread.blocksmith's hammer  
 Manche trimatières pour massette antieffilement

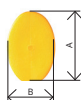

COD. ART.	L mm	A mm	B mm	BOX	COD. EAN - 13
<b>3026 MG</b>	260	40	27	20	80 3264633 078 6
Mercato / Markets / Marchés					



### Manico anima in fibra di vetro per piccone italiano occhio ovale

Fiberglass core italian type pickaxe handle with oval eye  
Manche bimatières pour pioche modèle italien avec oeil ovale



COD. ART.	L mm	A mm	B mm	BOX	COD. EAN - 13
4091/PO	910	55	40	20	80 3264633 251 3
4100/PO	1000	55	40	20	80 3264633 009 0

Mercato / Markets / Marchés

### Manico anima in fibra di vetro per piccone francese occhio rotondo

Fiberglass core french type pickaxe handle with round eye  
Manche bimatières pour pioche français italien avec oeil rond



COD. ART.	L mm	A mm	B mm	BOX	COD. EAN - 13
4091/PT	910	48	48	20	80 3264633 010 6
4100/PT	1000	48	48	20	80 3264633 011 3

Mercato / Markets / Marchés

### Manico anima in fibra di vetro per mazze / mazzescuri / asce

Fiberglass core handle for sledgehammers / axes  
Manche bimatières pour masses / merlins / haches

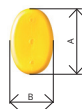

COD. ART.	L mm	A mm	B mm	BOX	COD. EAN - 13
4091/M	910	49	32	20	80 3264633 252 0
4100/M	1000	49	32	20	80 3264633 013 7

Mercato / Markets / Marchés

### Manico anima in fibra di vetro per martello carpentiere greco "Skeparni"

Fiberglass core handle for Greek carpenter's hammer "Skeparni"  
Manche bimatières pour marteau de coffreur grec "Skeparni"



COD. ART.	L mm	A mm	B mm	BOX	COD. EAN - 13
40 GR 38	380	34	34	20	80 3264633 020 5

Mercato / Markets / Marchés

MARTELLERIA 4

MAZZE e PICCONI 20

SCALPELLI e LEVERINI 24

ARTICOLI PER PIETRA 26

SECCHI, CAZZUOLE, SPATOLE e VARIE 27

BADILI, PALE, RASCHIETTI e RASCHIAFANGO 39

ACCETTE, PICOZZINI, RONCOLE e MACETE 52

ASCE, MAZZESCURI e CUNEI 55

RASTRELLI, SARCHIATORI e AERATORI 61

SCOPE FOGLIE 69

RACCOLTA FRUTTA e TRATTAMENTO 78

NOVITÀ 84

FORCHE e VANGHE 90

ZAPPE, ZAPPINI, ATTREZZINI e FORBICI 94

MANICI FIBRA 101

MANICI MIX e LEGNO 115

ASTE TELESCOPICHE 123

ESPOSITORI 124

GUANTI 126

SOLLEVAMENTO e ANCORAGGIO 140

- 4 MARTELLERIA
- 20 MAZZE e PICCONI
- 24 SCALPELLI e LEVERINI
- 26 ARTICOLI PER PIETRA
- 27 SECCHI, CAZZUOLE, SPATOLE e VARIE
- 39 BADILI, PALE, RASCHIETTI e RASCHIAFANGO
- 52 ACCETTE, PICOZZINI, RONCOLE e MACETE
- 55 ASCE, MAZZESCURI e CUNEI
- 61 RASTRELLI, SARCHIATORI e AERATORI
- 69 SCOPE FOGLIE
- 78 RACCOLTA FRUTTA e TRATTAMENTO
- 84 NOVITÀ
- 90 FORCHE e VANGHE
- 94 ZAPPE, ZAPPINI, ATTREZZINI e FORBICI
- 101 MANICI FIBRA**
- 115 MANICI MIX e LEGNO
- 123 ASTE TELESCOPICHE
- 124 ESPOSITORI
- 126 GUANTI
- 140 SOLLEVAMENTO e ANCORAGGIO

### Manico anima in fibra di vetro per martello carpentiere / muratore / martellina

Fibreglass core handle for carpenter's hammer / chipping hammer / little pickaxe / mason's hammer  
 Manche bimatières pour marteau coffreur / décintrair à hache / décintrair à pic / martelette à briques



COD. ART.	L mm	A mm	B mm	BOX	COD. EAN - 13
4045 CA	450	36	27	20	80 3264633 187 5
4050 CA	500	36	27	20	80 3264633 253 7
4058 CA	580	36	27	20	80 3264633 259 9

Mercato / Markets / Marchés

### Manico anima in fibra di vetro per martello carpentiere "Bellota"

Fibreglass core handle for carpenter's hammer  
 Manche bimatières pour marteau de coffreur



COD. ART.	L mm	A mm	B mm	BOX	COD. EAN - 13
4045 CAB	450	37	28	20	80 3264633 017 5
4050 CAB	500	37	28	20	80 3264633 018 2

Mercato / Markets / Marchés

### Manico anima in fibra di vetro per martello carp. francese "Coffreur" accetta / accetta martello / gessatore

Fibreglass core handle for French carpenter's hammer / hatchet  
 Manche bimatière pour marteau "Coffreur" / hachette / hachette marteau

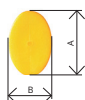

COD. ART.	L mm	A mm	B mm	BOX	COD. EAN - 13
4037/FA	370	38	27	20	80 3264633 019 9

Mercato / Markets / Marchés

### Manico anima in fibra di vetro per mazzetta antisfilamento

Fibreglass core handle for anti-unthreading blocksmith's hammer  
 Manche bimatières pour massette antieffilement

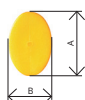

COD. ART.	L mm	A mm	B mm	BOX	COD. EAN - 13
3026 M	260	40	27	20	80 3264633 254 4

Mercato / Markets / Marchés

## Manici Mix

Struttura prodotto

I manici di questa famiglia sono costituiti da un corpo in legno costampato ad alta pressione da un rivestimento plastico in polipropilene nell'estremità in cui viene inserita la testa dell'attrezzo. Questi manici sono indeformabili in quanto non si ritirano per effetto dell'umidità e sono inoltre indeteriorabili poiché non marciscono nell'occhio, punto massimo di sforzo.

Il rivestimento plastico permette una maggiore resistenza agli urti e impedisce la torsione dell'utensile.

Handles belonging to this family are composed by a wooden body with a high pressure co-molded polypropylene extremity in which we insert the head of the tool. These handles are non-deformable because they do not shrink because of dampness and are also non perishable, because they do not deteriorate in the eye, point of greatest stress.

The plastic coating allows a greater resistance to shock and prevents the twisting of the tool.

Les manches qui font partie de cette famille sont composés par un corp en bois imprimé à haute pression avec une partie plastique en polypropylène dans laquelle est insérée la tête de l'outil. Ces manches sont indéformables, car ils ne se rétractent pas avec l'effet produit par l'humidité, ils sont impérissables aussi parce qu'ils ne pourrissent pas dans la douille, point d'effort maximum.

Le revêtement en matière plastique permet une plus grande résistance aux chocs et empêche la torsion de l'outil.

### Manico in legno per piccone italiano occhio ovale Mix

Italian model oval eye Mix  
Modèle italien douille ovale Mix



COD. ART.	L mm	A mm	B mm	BOX	COD. EAN - 13
4095 POL/MIX	950	55	40	20	80 3264633 203 2
Mercato / Markets / Marchés					

### Manico in legno per piccone francese occhio rotondo Mix

French model round eye Mix  
Modèle français douille ronde Mix



COD. ART.	L mm	A mm	B mm	BOX	COD. EAN - 13
4091 PTL/MIX	910	48	48	20	80 3264633 223 0
Mercato / Markets / Marchés					

### Manico in legno per mazza / mazza scure / ascia Mix

Wooden handle for sledgehammers Mix  
Manche en bois pour masses Mix

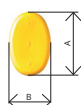

COD. ART.	L mm	A mm	B mm	BOX	COD. EAN - 13
4090 ML/MIX	910	49	32	20	80 3264633 204 9
Mercato / Markets / Marchés					

MARTELLERIA 4

MAZZE e  
PICCONI 20

SCALPELLI e  
LEVERINI 24

ARTICOLI PER  
PIETRA 26

SECCHI, CAZZUOLE,  
SPATOLE e VARIE 27

BADILI, PALE,  
RASCHIETTI  
e RASCHIAFANGO 39

ACCETTE, PICOZZINI,  
RONCOLE e MACETE 52

ASCE, MAZZESCURI  
e CUNEI 55

RASTRELLI,  
SARCHIATORI  
e AERATORI 61

SCOPE FOGLIE 69

RACCOLTA FRUTTA  
e TRATTAMENTO 78

NOVITÀ 84

FORCHE  
e VANGHE 90

ZAPPE, ZAPPINI,  
ATTREZZINI  
e FORBICI 94

MANICI FIBRA 101

MANICI MIX  
e LEGNO 115

ASTE  
TELESCOPICHE 123

ESPOSITORI 124

GUANTI 126

SOLLEVAMENTO  
e ANCORAGGIO 140

- 4 MARTELLERIA
- 20 MAZZE e PICCONI
- 24 SCALPELLI e LEVERINI
- 26 ARTICOLI PER PIETRA
- 27 SECCHI, CAZZUOLE, SPATOLE e VARIE
- 39 BADILI, PALE, RASCHIETTI e RASCHIAFANGO
- 52 ACCETTE, PICOZZINI, RONCOLE e MACETE
- 55 ASCE, MAZZESCURI e CUNEI
- 61 RASTRELLI, SARCHIATORI e AERATORI
- 69 SCOPE FOGLIE
- 78 RACCOLTA FRUTTA e TRATTAMENTO
- 84 NOVITÀ
- 90 FORCHE e VANGHE
- 94 ZAPPE, ZAPPINI, ATTREZZINI e FORBICI
- 101 MANICI FIBRA
- 115 MANICI MIX e LEGNO**
- 123 ASTE TELESCOPICHE
- 124 ESPOSITORI
- 126 GUANTI
- 140 SOLLEVAMENTO e ANCORAGGIO

### Manico in legno per martello carpentiere / muratore / martellina Mix

Wooden handle for carpenter's hammer / chipping hammer / little pickaxe / mason's hammer Mix  
 Manche en bois pour marteau de coffreur / décintrouir à hache / décintrouir à pic / martelette à briques Mix



COD. ART.	L mm	A mm	B mm	BOX	COD. EAN - 13
4038 CAL/MIX	380	36	26	20	80 3264633 224 7
4045 CAL/MIX	450	36	26	20	80 3264633 206 3
4060 CAL/MIX	600	36	26	20	80 3264633 205 6
4045 CBL/MIX	450	37	28	20	80 3264633 225 4
4060 CBL/MIX	600	37	28	20	80 3264633 218 6

Mercato / Markets / Marchés

### Manico in legno per martello carpentiere francese "Coffreur" accetta / accetta martello / gessatore Mix

Wooden handle for french carpenter's hammer / hatchets Mix  
 Manche en bois pour marteau coffreur / hachette / hachette à tête Mix

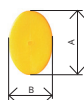

COD. ART.	L mm	A mm	B mm	BOX	COD. EAN - 13
4037/FAL/MIX	370	38	27	20	80 3264633 226 1

Mercato / Markets / Marchés

### Manico in legno per mazzetta antisfilamento Mix

Wooden handle for anti-unthreading blocksmith's hammer Mix  
 Manche en bois pour massette antiefillement Mix

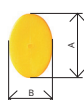

COD. ART.	L mm	A mm	B mm	BOX	COD. EAN - 13
3026 ML/MIX	260	40	27	20	80 3264633 207 0

Mercato / Markets / Marchés

### Manico in legno per zappino Ø 28/30 Mix

Wooden handle for weeding hoe-eye Ø 28/30 Mix  
Manche de serfouette en bois Mix Ø 28/30



COD. ART.	L mm	A mm	B mm	BOX	COD. EAN - 13
28130 ZL/MIX	1300	32	32	20	80 3264633 231 5
30130 ZL/MIX	1300	34	34	20	80 3264633 230 8

Mercato / Markets / Marchés



### Manico legno tondo per zappa Ø 35/40/45 Mix

Wooden handle for hoe-round eye Ø 35/40/45 Mix  
Manche de houe en bois Mix Ø 35/40/45



COD. ART.	L mm	A mm	B mm	BOX	COD. EAN - 13
35140 ZL/MIX	1400	36	36	20	80 3264633 229 2
40140 ZL/MIX	1400	41	41	20	80 3264633 228 5
45140 ZL/MIX	1400	47	47	20	80 3264633 228 5

Mercato / Markets / Marchés



### Manico in legno per zappa occhio ovale Mix

Wooden handle for hoe-oval eye Mix  
Manche de houe en bois Mix douille oval

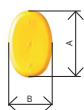

COD. ART.	L mm	A mm	B mm	BOX	COD. EAN - 13
OV140 ZL/MIX	1400	49	32	20	80 3264633 232 2

Mercato / Markets / Marchés



MARTELLERIA	4
MAZZE e PICCONI	20
SCALPELLI e LEVERINI	24
ARTICOLI PER PIETRA	26
SECCHI, CAZZUOLE, SPATOLE e VARIE	27
BADILI, PALE, RASCHIETTI e RASCHIAFANGO	39
ACCETTE, PICOZZINI, RONCOLE e MACETE	52
ASCE, MAZZESCURI e CUNEI	55
RASTRELLI, SARCHIATORI e AERATORI	61
SCOPE FOGLIE	69
RACCOLTA FRUTTA e TRATTAMENTO	78
NOVITÀ	84
FORCHE e VANGHE	90
ZAPPE, ZAPPINI, ATTREZZINI e FORBICI	94
MANICI FIBRA	101
<b>MANICI MIX e LEGNO</b>	<b>115</b>
ASTE TELESCOPICHE	123
ESPOSITORI	124
GUANTI	126
SOLLEVAMENTO e ANCORAGGIO	140

- 4 MARTELLERIA
- 20 MAZZE e PICCONI
- 24 SCALPELLI e LEVERINI
- 26 ARTICOLI PER PIETRA
- 27 SECCHI, CAZZUOLE, SPATOLE e VARIE
- 39 BADILI, PALE, RASCHIETTI e RASCHIAFANGO
- 52 ACCETTE, PICOZZINI, RONCOLE e MACETE
- 55 ASCE, MAZZESCURI e CUNEI
- 61 RASTRELLI, SARCHIATORI e AERATORI
- 69 SCOPE FOGLIE
- 78 RACCOLTA FRUTTA e TRATTAMENTO
- 84 NOVITÀ
- 90 FORCHE e VANGHE
- 94 ZAPPE, ZAPPINI, ATTREZZINI e FORBICI
- 101 MANICI FIBRA
- 115 MANICI MIX e LEGNO**
- 123 ASTE TELESCOPICHE
- 124 ESPOSITORI
- 126 GUANTI
- 140 SOLLEVAMENTO e ANCORAGGIO

### Manico in legno faggio per badile

Beech-wood handle for shovel  
Manche en bois de hêtre pour pelle



COD. ART.	L mm	A mm	B mm	BOX	COD. EAN - 13
<b>1140 BL</b>	1400	30	40	25	80 3264633 182 0

Mercato / Markets / Marchés

### Manico in legno frassino verniciato per badile

Varnished ash-wood handle for shovel  
Manche en bois frêne verni pour pelle



COD. ART.	L mm	A mm	B mm	BOX	COD. EAN - 13
<b>1140 BLFV</b>	1400	30	40	25	80 5773372 240 4

Mercato / Markets / Marchés

### Manico in legno per badile superleggero "Piuma"

Wooden handle for shovel "Feather"  
Manche en bois pour pelle très légère "Plume"



COD. ART.	L mm	A mm	B mm	BOX	COD. EAN - 13
<b>1140 BLP</b>	1400	30	40	25	80 3264633 183 7

Mercato / Markets / Marchés

### Manico in legno faggio per forca

Beech-wood handle for fork  
Manche en bois de hêtre pour forche



COD. ART.	L mm	A mm	B mm	BOX	COD. EAN - 13
<b>1140 FL</b>	1400	28	36	25	80 5773372 250 3

Mercato / Markets / Marchés

### Manico in legno dritto per vanghe e pale collo di cigno

Straight wooden handle for spades and swan neck shovels  
Manche en bois droit pour bêches et pelles à col de cygne

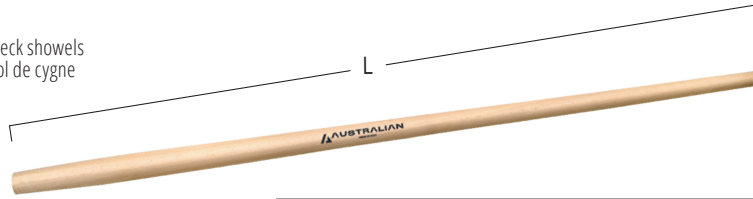

COD. ART.	L mm	A mm	B mm	BOX	COD. EAN - 13
1110VL	1100	30	40	25	80 3264633 969 7
1140VL	1400	30	40	25	80 3264633 120 2
Mercato / Markets / Marchés					

### Manico in legno per rastrello

Wooden handle for rakes and brooms  
Manche en bois pour rateaux, balais e outils a douille



COD. ART.	L mm	A mm	B mm	BOX	COD. EAN - 13
150 RACON L	1500	18	26	25	80 3264633 279 7
150 RACON L/28	1500	18	28	25	80 5773372 470 5
180 RACON L	1800	18	26	25	80 3264633 321 3
180 RACON L/28	1800	18	28	25	80 5773372 471 2
Mercato / Markets / Marchés					

### Manico in legno per scope con filettatura

Wooden handle for brooms with screw heads  
Manche en bois pour balais avec filetage



COD. ART.	L mm	A mm	B mm	BOX	COD. EAN - 13
130 S	1300	20	24	25	80 5773372 180 3
Mercato / Markets / Marchés					

### Manico in legno zappe occhio tondo

Wooden handle for hoe - conic eye  
Manche de houe en bois - douille ronde



COD. ART.	L mm	A mm	BOX	COD. EAN - 13
30130L	1300	30	25	80 3264633 412 8
35140L	1400	35	25	80 3264633 413 5
40140L	1400	40	25	80 3264633 414 2
45140L	1400	45	25	80 5773372 297 8
Mercato / Markets / Marchés				

### Manico in legno dritto per raschietto

Wooden handle for scraper  
Manche de houe en bois pour grattoir

COD. ART.	L mm	A mm	B mm	BOX	COD. EAN - 13
1110RL	1100	24	30	25	80 5773372 610 5
Mercato / Markets / Marchés					

MARTELLERIA	4
MAZZE e PICCONI	20
SCALPELLI e LEVERINI	24
ARTICOLI PER PIETRA	26
SECCHI, CAZZUOLE, SPATOLE e VARIE	27
BADILI, PALE, RASCHIETTI e RASCHIAFANGO	39
ACCETTE, PICOZZINI, RONCOLE e MACETE	52
ASCE, MAZZESCURI e CUNEI	55
RASTRELLI, SARCHIATORI e AERATORI	61
SCOPE FOGLIE	69
RACCOLTA FRUTTA e TRATTAMENTO	78
NOVITÀ	84
FORCHE e VANGHE	90
ZAPPE, ZAPPINI, ATTREZZINI e FORBICI	94
MANICI FIBRA	101
<b>MANICI MIX e LEGNO</b>	<b>115</b>
ASTE TELESCOPICHE	123
ESPOSITORI	124
GUANTI	126
SOLLEVAMENTO e ANCORAGGIO	140

- 4 MARTELLERIA
- 20 MAZZE e PICCONI
- 24 SCALPELLI e LEVERINI
- 26 ARTICOLI PER PIETRA
- 27 SECCHI, CAZZUOLE, SPATOLE e VARIE
- 39 BADILI, PALE, RASCHIETTI e RASCHIAFANGO
- 52 ACCETTE, PICOZZINI, RONCOLE e MACETE
- 55 ASCE, MAZZESCURI e CUNEI
- 61 RASTRELLI, SARCHIATORI e AERATORI
- 69 SCOPE FOGLIE
- 78 RACCOLTA FRUTTA e TRATTAMENTO
- 84 NOVITÀ
- 90 FORCHE e VANGHE
- 94 ZAPPE, ZAPPINI, ATTREZZINI e FORBICI
- 101 MANICI FIBRA
- 115 MANICI MIX e LEGNO**
- 123 ASTE TELESCOPICHE
- 124 ESPOSITORI
- 126 GUANTI
- 140 SOLLEVAMENTO e ANCORAGGIO

### Manico in legno zappe occhio quadro

Wooden handle for hoe - square eye  
Manche de houe en bois - douille carré



COD. ART.	L mm	A mm	BOX	COD. EAN - 13
35110QL	1100	35	25	80 5773372 138 4
35140QL	1400	35	25	80 5773372 139 1
40110QL	1100	40	25	80 5773372 140 7
40140QL	1400	40	25	80 5773372 141 4
45110QL	1100	45	25	80 5773372 142 1
45140QL	1400	45	25	80 5773372 143 8

Mercato / Markets / Marchés

### Manico in legno zappa ovale

Wooden handle for hoe-oval eye  
Manche de houe en bois douille oval



COD. ART.	L mm	A mm	B mm	BOX	COD. EAN - 13
OV 140 ZL	1400	35	49	25	80 3264633 502 6

Mercato / Markets / Marchés

### Manico in legno zappino ovale

Wooden handle for small hoe-oval eye  
Manche de houe en bois douille oval



COD. ART.	L mm	A mm	B mm	BOX	COD. EAN - 13
OV 120 ZL/S	1200	33	43	25	80 5773372 302 9

Mercato / Markets / Marchés

### Manico in legno "Marra Sarda"

Wooden handle for hoe-square eye "Marra Sarda"  
Manche de houe en bois "Marra Sarda"



COD. ART.	L mm	A mm	B mm	BOX	COD. EAN - 13
M.MARRA	1200	30	45	25	80 3264633 501 9

Mercato / Markets / Marchés



### Manico in legno per picconi

Wooden handle for pickaxe  
Manche en bois pour pioche



COD. ART.	L mm	A mm	B mm	BOX	COD. EAN - 13
4095 POL	950	55	40	25	80 3264633 184 4
Mercato / Markets / Marchés					

### Manico in legno per mazze

Wooden handle for sledgehammers  
Manche en bois pour masses



COD. ART.	L mm	A mm	B mm	BOX	COD. EAN - 13
4090 ML	900	49	35	25	80 3264633 185 1
Mercato / Markets / Marchés					

### Manico in legno per martello carpentiere muratore / martellina (tipo Italia)

Wooden handle for carpenter's hammer / chipping hammer / little pickaxe / mason's hammer  
Manche en bois pour marteau de coffreur / décintrioir à hache / décintrioir à pic / martelletta à briques



COD. ART.	L mm	A mm	B mm	BOX	COD. EAN - 13
4038 CAL	380	36	27	20	80 3264633 186 8
4045 CAL	450	38	29	20	80 3264633 490 6
4060 CAL	600	38	29	20	80 3264633 188 2
Mercato / Markets / Marchés					

### Manico in legno per martello carpentiere tipo bragotto

Wooden handle for carpenter's hammer Bragotto style  
Manche en bois pour marteau coffreur modèle Bragotto



COD. ART.	L mm	A mm	B mm	BOX	COD. EAN - 13
4060BRL	600	43	32	20	80 5773372 162 9
Mercato / Markets / Marchés					

### Manico in legno per mazzetta antisfilamento

Wooden handle for anti-unthreading blocksmith's hammer  
Manche en bois pour massette antieffilement



COD. ART.	L mm	A mm	B mm	BOX	COD. EAN - 13
3026 ML	280	40	27	20	80 3264633 190 5
Mercato / Markets / Marchés					

MARTELLERIA	4
MAZZE e PICCONI	20
SCALPELLI e LEVERINI	24
ARTICOLI PER PIETRA	26
SECCHI, CAZZUOLE, SPATOLE e VARIE	27
BADILI, PALE, RASCHIETTI e RASCHIAFANGO	39
ACCETTE, PICOZZINI, RONCOLE e MACETE	52
ASCE, MAZZESCURI e CUNEI	55
RASTRELLI, SARCHIATORI e AERATORI	61
SCOPE FOGLIE	69
RACCOLTA FRUTTA e TRATTAMENTO	78
NOVITÀ	84
FORCHE e VANGHE	90
ZAPPE, ZAPPINI, ATTREZZINI e FORBICI	94
MANICI FIBRA	101
<b>MANICI MIX e LEGNO</b>	<b>115</b>
ASTE TELESCOPICHE	123
ESPOSITORI	124
GUANTI	126
SOLLEVAMENTO e ANCORAGGIO	140

- 4 MARTELLERIA
- 20 MAZZE e PICCONI
- 24 SCALPELLI e LEVERINI
- 26 ARTICOLI PER PIETRA
- 27 SECCHI, CAZZUOLE, SPATOLE e VARIE
- 39 BADILI, PALE, RASCHIETTI e RASCHIAFANGO
- 52 ACCETTE, PICOZZINI, RONCOLE e MACETE
- 55 ASCE, MAZZESCURI e CUNEI
- 61 RASTRELLI, SARCHIATORI e AERATORI
- 69 SCOPE FOGLIE
- 78 RACCOLTA FRUTTA e TRATTAMENTO
- 84 NOVITÀ
- 90 FORCHE e VANGHE
- 94 ZAPPE, ZAPPINI, ATTREZZINI e FORBICI
- 101 MANICI FIBRA
- 115 MANICI MIX e LEGNO**
- 123 ASTE TELESCOPICHE
- 124 ESPOSITORI
- 126 GUANTI
- 140 SOLLEVAMENTO e ANCORAGGIO

### Manico in legno per mazzetta occhio bi-conico in confezione con cuneo

Wooden handle for blocksmith's hammer biconical eye in box with wedges  
 Manche en bois pour massette douille biconique en emballage avec coins



COD. ART.	L mm	Mazz. gr.	BOX	COD. EAN - 13
M0810FVC	260	800/1000	6	80 5773372 163 6
M1215FVC	280	1200/1500	6	80 5773372 164 3
M20FVC	300	2000	6	80 5773372 165 0

Mercato / Markets / Marchés

### Manico in legno per martelli da banco in confezione con cuneo

Wooden handle for carpenter's hammer in box with wedges  
 Manche en bois pour marteau coffreur en emballage avec coins



COD. ART.	L mm	Mazz. gr.	BOX	COD. EAN - 13
TT1FVC	260	100	6	80 5773372 145 2
TT2FVC	280	200	6	80 5773372 146 9
TT3FVC	300	300	6	80 5773372 147 6
TT4FVC	310	400	6	80 5773372 148 3
TT5FVC	320	500	6	80 5773372 149 0
TT6FVC	330	600	6	80 5773372 150 6
TT8FVC	350	800	6	80 5773372 151 3
TT10FVC	360	1000	6	80 5773372 152 0
TT15FVC	380	1500	6	80 5773372 153 7
TT20FVC	400	2000	6	80 5773372 154 4

Mercato / Markets / Marchés

### Manico in legno per lima

Wooden file handle  
 Manche en bois pour lime





COD. ART.	L mm	BOX	COD. EAN - 13
MLL 2	100	10	80 5773372 363 0
MLL 3	110	10	80 5773372 364 7
MLL 4	120	10	80 5773372 365 4
MLL 5	130	10	80 5773372 366 1
MLL 6	140	10	80 5773372 367 8

Mercato / Markets / Marchés

### Asta telescopica a 2 sfilamenti con bloccaggio a perno attacco conico + filetto

2 section extension pole with step lock conic connection + thread  
Barre télescopique à 2 sections avec blocage à pivot fixation conique + filet

COD. ART.	L Min. mm	L Max. mm	BOX	COD. EAN - 13
AT30	1750	3000	6	80 3264633 678 8
AT45	2500	4500	6	80 3264633 679 5

Mercato / Markets / Marchés  

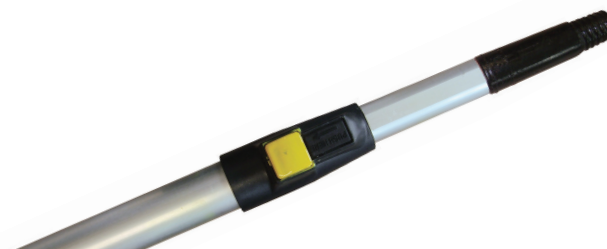

### Asta telescopica a 3 sfilamenti con bloccaggio a perno attacco conico + filetto

3 section extension pole with step lock conic connection + thread  
Barre télescopique à 3 sections avec blocage à pivot fixation conique + filet

COD. ART.	L Min. mm	L Max. mm	BOX	COD. EAN - 13
AT60	2400	6000	6	80 3264633 680 1



Mercato / Markets / Marchés  



### Asta telescopica a 2 sfilamenti con bloccaggio a perno attacco agricolo Ø 25 mm

2 sections extension pole with step lock agricultural connection Ø 25 mm  
Barre télescopique à 2 sections avec blocage à pivot fixation agricole Ø 25 mm

COD. ART.	L Min. mm	L Max. mm	BOX	COD. EAN - 13
AT30A	1750	3000	6	80 5773372 155 1
AT45A	2500	4500	6	80 5773372 156 8

Mercato / Markets / Marchés  



### Asta telescopica a 3 sfilamenti con bloccaggio a perno attacco agricolo Ø 25 mm

3 sections extension pole with step lock agricultural connection Ø 25 mm  
Barre télescopique à 3 sections avec blocage à pivot fixation agricole Ø 25 mm

COD. ART.	L Min. mm	L Max. mm	BOX	COD. EAN - 13
AT60A	2400	6000	6	80 5773372 157 5

Mercato / Markets / Marchés  



MARTELLERIA 4

MAZZE e PICCONI 20

SCALPELLI e LEVERINI 24

ARTICOLI PER PIETRA 26

SECCHI, CAZZUOLE, SPATOLE e VARIE 27

BADILI, PALE, RASCHIETTI e RASCHIAFANGO 39

ACCETTE, PICOZZINI, RONCOLE e MACETE 52

ASCE, MAZZESCURI e CUNEI 55

RASTRELLI, SARCHIATORI e AERATORI 61

SCOPE FOGLIE 69

RACCOLTA FRUTTA e TRATTAMENTO 78

NOVITÀ 84

FORCHE e VANGHE 90

ZAPPE, ZAPPINI, ATTREZZINI e FORBICI 94

MANICI FIBRA 101

MANICI MIX e LEGNO 115

ASTE TELESCOPICHE 123

ESPOSITORI 124

GUANTI 126

SOLLEVAMENTO e ANCORAGGIO 140

- 4 MARTELLERIA
- 20 MAZZE e PICCONI
- 24 SCALPELLI e LEVERINI
- 26 ARTICOLI PER PIETRA
- 27 SECCHI, CAZZUOLE, SPATOLE e VARIE
- 39 BADILI, PALE, RASCHIETTI e RASCHIAFANGO
- 52 ACCETTE, PICOZZINI, RONCOLE e MACETE
- 55 ASCE, MAZZESCURI e CUNEI
- 61 RASTRELLI, SARCHIATORI e AERATORI
- 69 SCOPE FOGLIE
- 78 RACCOLTA FRUTTA e TRATTAMENTO
- 84 NOVITÀ
- 90 FORCHE e VANGHE
- 94 ZAPPE, ZAPPINI, ATTREZZINI e FORBICI
- 101 MANICI FIBRA
- 115 MANICI MIX e LEGNO
- 123 ASTE TELESCOPICHE
- 124 **ESPOSITORI**
- 126 GUANTI
- 140 SOLLEVAMENTO e ANCORAGGIO



**Espositore da banco per scalpelli**

Table stand for chisels  
Présentoir de coinfor pour ciseaux

COD. ART.	Gr.	H mm	BOX	COD. EAN - 13
EBS	1300	300	1 pz.	80 3264633 441 8
Mercato / Markets / Marchés <span style="float: right;">EU</span>				

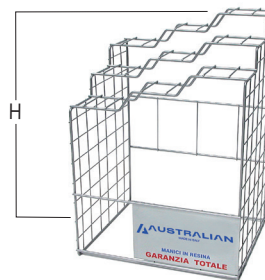

**Espositore da banco**

Table stand  
Présentoir de coinfor

COD. ART.	Gr.	H mm	BOX	COD. EAN - 13
EB	1600	570	1 pz.	80 3264633 442 5
Mercato / Markets / Marchés <span style="float: right;">EU</span>				



**Espositore da banco per spatole**

Table stand for scrapers  
Présentoir de coinfor pour spatules

COD. ART.	Gr.	H mm	BOX	COD. EAN - 13
EBS	1000	680	1 pz.	80 5773372 368 5
Mercato / Markets / Marchés <span style="float: right;">EU</span>				



**Espositore da pavimento**

Floor stand  
Présentoir de sol

COD. ART.	Gr.	H mm	BOX	COD. EAN - 13
EM	6500	800	1 pz.	80 3264633 442 5
EMIX	6700	2000	1 pz.	80 3264633 442 5
Mercato / Markets / Marchés <span style="float: right;">EU</span>				



**Espositore in cartone da pavimento 42 fori**

Floor cardboard stand 42 holes  
Présentoir de sol en carton 42 trous

COD. ART.	A mm	B mm	BOX	COD. EAN - 13
E42F	600	800	1	80 3264633 442 5
Mercato / Markets / Marchés <span style="float: right;">EU</span>				

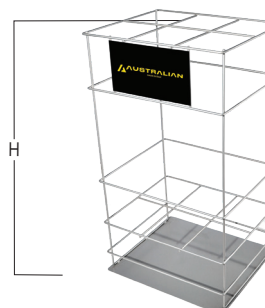

**Espositore da pavimento per manici lunghi**

Floor stand for long handles  
Présentoir de sol pour manches longs

COD. ART.	Gr.	H mm	BOX	COD. EAN - 13
EML	6500	800	1	80 3264633 442 5
Mercato / Markets / Marchés <span style="float: right;">EU</span>				

**Espositore guanti da pavimento**

Floor stand for gloves  
Présentoir de sol pour gants

COD. ART.	A mm	B mm	BOX	COD. EAN - 13
EG	530	2000	1	80 3264633 280 3
Mercato / Markets / Marchés				<b>EU</b>

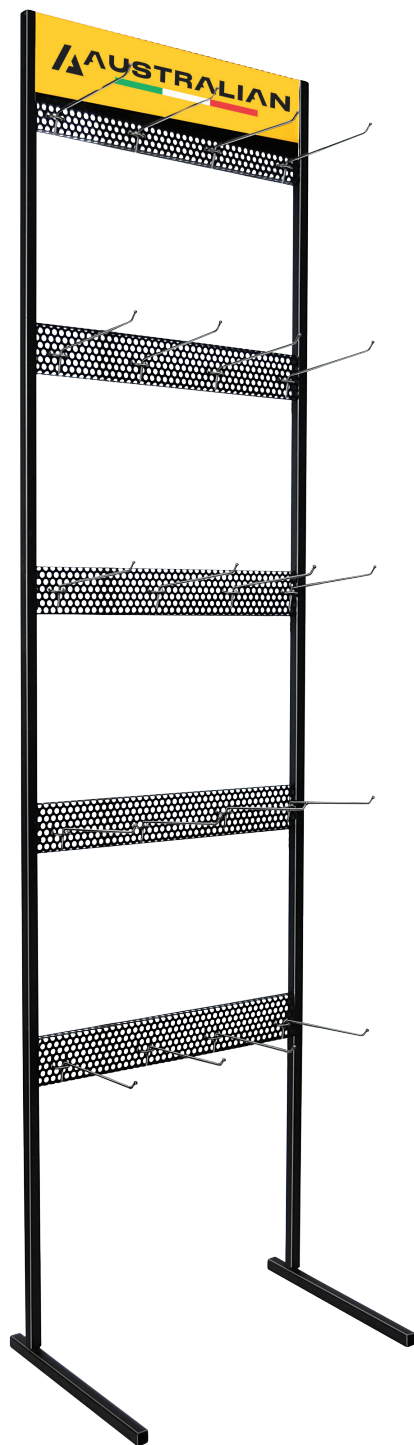

MARTELLERIA 4

MAZZE e PICCONI 20

SCALPELLI e LEVERINI 24

ARTICOLI PER PIETRA 26

SECCHI, CAZZUOLE, SPATOLE e VARIE 27

BADILI, PALE, RASCHIETTI e RASCHIAFANGO 39

ACCETTE, PICOZZINI, RONCOLE e MACETE 52

ASCE, MAZZESCURI e CUNEI 55

RASTRELLI, SARCHIATORI e AERATORI 61

SCOPE FOGLIE 69

RACCOLTA FRUTTA e TRATTAMENTO 78

NOVITÀ 84

FORCHE e VANGHE 90

ZAPPE, ZAPPINI, ATTREZZINI e FORBICI 94

MANICI FIBRA 101

MANICI MIX e LEGNO 115

ASTE TELESCOPICHE 123

**ESPOSITORI 124**

GUANTI 126

SOLLEVAMENTO e ANCORAGGIO 140

## GUANTI PELFLEX

PELFLEX GLOVES  
GANTS PELFLEX

COD. ART.	Tipo	Colore	Taglia	L mm	Confezione	BOX	COD. EAN - 13
GPEL07	Pelflex	Bianco	7	220	12 pz.	120 pz.	80 3264633 639 9
GPEL08	Pelflex	Bianco	8	230	12 pz.	120 pz.	80 3264633 640 5
GPEL09	Pelflex	Bianco	9	240	12 pz.	120 pz.	80 3264633 641 2
GPEL10	Pelflex	Bianco	10	250	12 pz.	120 pz.	80 3264633 642 9
GPEL11	Pelflex	Bianco	11	260	12 pz.	120 pz.	80 3264633 643 6

Cat 2. Testati secondo la Norma EN 388	Livello
Resistenza all'abrasione	3
Resistenza al taglio di lama	1
Resistenza allo strappo	3
Resistenza alla puntura	3

Confezionamento
<b>Appendino</b> Hanger Cintre



### OTTIMA MORBIDEZZA

Excellent softness  
Excellente souplesse

### PALMO E DORSO IN PELLE FIORE BOVINO

Palm and back in cow grain leather  
Empaumure et dos en peau fleur bovine

### BUONA DURATA

Good duration  
Bonne durée

### BORDO IN TELA

Canvas edge  
Bordure en toile

### ELASTICO SUL DORSO

Elastic bend on the back  
Elastique sur le dos



**Pelflex**  
**GPEL07**  
EN388:2016  
  
**SIZE 7**  
3133X AUSTRALIAN SRL  
Via Nuova 15 - 10091  
CATU CAVOUR (TO) - ITALY

# GUANTI GREENPEL

GREENPEL GLOVES  
GANTS GREENPEL

COD. ART.	Tipo	Colore	Taglia	L mm	Confezione	BOX	COD. EAN - 13
EP 07	Greenpel	Bianco	7	220	12 pz.	120 pz.	80 5773372 276 3
EP 08	Greenpel	Bianco	8	230	12 pz.	120 pz.	80 5773372 277 0
EP 09	Greenpel	Bianco	9	240	12 pz.	120 pz.	80 5773372 278 7
EP 10	Greenpel	Bianco	10	250	12 pz.	120 pz.	80 5773372 279 4
EP 11	Greenpel	Bianco	11	260	12 pz.	120 pz.	80 5773372 280 0

Cat 2. Testati secondo la Norma EN 388	Livello
Resistenza all'abrasione	3
Resistenza al taglio di lama	1
Resistenza allo strappo	3
Resistenza alla puntura	3

Confezionamento	
Appendino	
Hanger	
Cintre	

## BUONA MORBIDEZZA

Good softness  
Bonne souplesse

## PALMO E DORSO IN PELLE FIORE BUFALO

Palm and back in buffalo grain leather  
Empaumure et dos en peau fleur buffle

## BUONA DURATA

Good duration  
Bonne durée

## BORDO IN TELA

Canvas edge  
Bordure en toile

## ELASTICO SUL DORSO

Elastic bend on the back  
Elastique sur le dos



MARTELLERIA 4

MAZZE e PICCONI 20

SCALPELLI e LEVERINI 24

ARTICOLI PER PIETRA 26

SECCHI, CAZZUOLE, SPATOLE e VARIE 27

BADILI, PALE, RASCHIETTI e RASCHIAFANGO 39

ACCETTE, PICOZZINI, RONCOLE e MACETE 52

ASCE, MAZZESCURI e CUNEI 55

RASTRELLI, SARCHIATORI e AERATORI 61

SCOPE FOGLIE 69

RACCOLTA FRUTTA e TRATTAMENTO 78

NOVITÀ 84

FORCHE e VANGHE 90

ZAPPE, ZAPPINI, ATTREZZINI e FORBICI 94

MANICI FIBRA 101

MANICI MIX e LEGNO 115

ASTE TELESCOPICHE 123

ESPOSITORI 124

**GUANTI 126**

SOLLEVAMENTO e ANCORAGGIO 140

## GUANTI VEFLEX

VELFLEX GLOVES  
GANTS VEFLEX

COD. ART.	Tipo	Colore	Taglia	L mm	Confezione	BOX	COD. EAN - 13
VEL 07	Velflex	Bianco	7	220	12 pz.	120 pz.	80 5773372 271 8
VEL 08	Velflex	Bianco	8	230	12 pz.	120 pz.	80 5773372 272 5
VEL 09	Velflex	Bianco	9	240	12 pz.	120 pz.	80 5773372 273 2
VEL 10	Velflex	Bianco	10	250	12 pz.	120 pz.	80 5773372 274 9
VEL 11	Velflex	Bianco	11	260	12 pz.	120 pz.	80 5773372 275 6

Cat 2. Testati secondo la Norma EN 388	Livello
Resistenza all'abrasione	3
Resistenza al taglio di lama	1
Resistenza allo strappo	2
Resistenza alla puntura	2

Confezionamento
<b>Appendino</b> Hanger Cintre



### OTTIMA MORBIDEZZA

Excellent softness  
Excellente souplesse

### PALMO IN CAPRETTO DORSO IN TELA

Kidskin palm with canvas on the back  
Empaumure en chèvre et dos en toile

### BUONA DURATA

Good duration  
Bonne durée

### BORDO ELASTICO

Elastic edge  
Bordure élastique

### CHIUSURA CON VELCRO

Velcro fastening  
Fermeture velcro



- 4 MARTELLERIA
- 20 MAZZE e PICCONI
- 24 SCALPELLI e LEVERINI
- 26 ARTICOLI PER PIETRA
- 27 SECCHI, CAZZUOLE, SPATOLE e VARIE
- 39 BADILI, PALE, RASCHIETTI e RASCHIAFANGO
- 52 ACCETTE, PICOZZINI, RONCOLE e MACETE
- 55 ASCE, MAZZESCURI e CUNEI
- 61 RASTRELLI, SARCHIATORI e AERATORI
- 69 SCOPE FOGLIE
- 78 RACCOLTA FRUTTA e TRATTAMENTO
- 84 NOVITÀ
- 90 FORCHE e VANGHE
- 94 ZAPPE, ZAPPINI, ATTREZZINI e FORBICI
- 101 MANICI FIBRA
- 115 MANICI MIX e LEGNO
- 123 ASTE TELESCOPICHE
- 124 ESPOSITORI
- 126 **GUANTI**
- 140 SOLLEVAMENTO e ANCORAGGIO



## GUANTI BLACK DOT AIRFLEX

BLACK DOT AIRFLEX GLOVES  
GANTS BLACK DOT AIRFLEX

COD. ART.	Tipo	Colore	Taglia	L mm	Confezione	BOX	COD. EAN - 13
16145 GNP 07	Black Dot Airflex	Nero	7	220	12 pz.	144 pz.	80 3264633 672 6
16145 GNP 08	Black Dot Airflex	Nero	8	230	12 pz.	144 pz.	80 3264633 673 3
16145 GNP 09	Black Dot Airflex	Nero	9	240	12 pz.	144 pz.	80 3264633 674 0
16145 GNP 10	Black Dot Airflex	Nero	10	250	12 pz.	144 pz.	80 3264633 675 7
16145 GNP 11	Black Dot Airflex	Nero	11	260	12 pz.	144 pz.	80 3264633 676 4

Cat 2. Testati secondo la Norma EN 388	Livello
Resistenza all'abrasione	4
Resistenza al taglio di lama	1
Resistenza allo strappo	4
Resistenza alla puntura	1

Confezionamento
Appendino
Hanger
Cintre



### OTTIMA SENSIBILITÀ

Excellent sensibility  
Excellente sensibilité

### TRASPIRANTI

Transpiring  
Transpirants



### GRIP ECCEZIONALE

Excellent grip  
Grip exceptionnel

**FILO NYLON  
OTTIMA QUALITÀ**  
Best quality nylon thread  
Fil de nylon de qualité excellente

### OTTIMA DESTREZZA

Excellent dexterity  
Excellente dextérité

MARTELLERIA 4

MAZZE e  
PICCONI 20

SCALPELLI e  
LEVERINI 24

ARTICOLI PER  
PIETRA 26

SECCHI, CAZZUOLE,  
SPATOLE e VARIE 27

BADILI, PALE,  
RASCHIETTI  
e RASCHIAFANGO 39

ACCETTE, PICOZZINI,  
RONCOLE e MACETE 52

ASCE, MAZZESCURI  
e CUNEI 55

RASTRELLI,  
SARCHIATORI  
e AERATORI 61

SCOPE FOGLIE 69

RACCOLTA FRUTTA  
e TRATTAMENTO 78

NOVITÀ 84

FORCHE  
e VANGHE 90

ZAPPE, ZAPPINI,  
ATTREZZINI  
e FORBICI 94

MANICI FIBRA 101

MANICI MIX  
e LEGNO 115

ASTE  
TELESCOPICHE 123

ESPOSITORI 124

**GUANTI 126**

SOLLEVAMENTO  
e ANCORAGGIO 140

## GUANTI RED FLEX

RED FLEX GLOVES  
GANTS RED FLEX

COD. ART.	Tipo	Colore	Taglia	L mm	Confezione	BOX	COD. EAN - 13
15145 GNP 07	Red Flex	Rosso	7	220	12 pz.	144 pz.	80 5773372 100 1
15145 GNP 08	Red Flex	Rosso	8	230	12 pz.	144 pz.	80 5773372 101 8
15145 GNP 09	Red Flex	Rosso	9	240	12 pz.	144 pz.	80 5773372 102 5
15145 GNP 10	Red Flex	Rosso	10	250	12 pz.	144 pz.	80 5773372 103 2
15145 GNP 11	Red Flex	Rosso	11	260	12 pz.	144 pz.	80 5773372 104 9

Cat 2. Testati secondo la Norma EN 388	Livello
Resistenza all'abrasione	3
Resistenza al taglio di lama	1
Resistenza allo strappo	2
Resistenza alla puntura	1

Confezionamento
<b>Appendino</b> Hanger Cintre



### OTTIMO GRIP

Excellent grip  
Grip exceptionnel

### DORSO E DITA AREATE

Areated back and fingers  
Doigts et dos ventilés



### TRASPIRANTI

Transpiring  
Transpirant

### FILO IN NYLON OTTIMA QUALITÀ

Best quality nylon thread  
Fil de nylon de qualité excellente

## GUANTI GARDENFLEX

GADENFLEX GLOVES  
GANTS GARDENFLEX

COD. ART.	Tipo	Colore	Taglia	L mm	Confezione	BOX	COD. EAN - 13
19145 GN 06	Gardenflex	Verde	6	210	12 pz.	120 pz.	80 3264633 575 0
19145 GN 07	Gardenflex	Verde	7	220	12 pz.	120 pz.	80 3264633 576 7
19145 GN 08	Gardenflex	Verde	8	230	12 pz.	120 pz.	80 3264633 577 4
19145 GN 09	Gardenflex	Verde	9	240	12 pz.	120 pz.	80 3264633 578 1
19145 GN 10	Gardenflex	Verde	10	250	12 pz.	120 pz.	80 3264633 579 8
19145 GN 11	Gardenflex	Verde	11	260	12 pz.	120 pz.	80 3264633 580 4

Cat 2. Testati secondo la Norma EN 388	Livello
Resistenza all'abrasione	4
Resistenza al taglio di lama	1
Resistenza allo strappo	2
Resistenza alla puntura	1

Confezionamento
Appendino
Hanger
Cintre



### IMPERMEABILE

Waterproof  
Impermeables

### BUONA SENSIBILITÀ

Good sensibility  
Bonne sensibilité



### GRIP ECCEZIONALE

Excellent grip  
Grip exceptionnel

### BUONA RESISTENZA

Good endurance  
Bonne résistance

MARTELLERIA	4
MAZZE e PICCONI	20
SCALPELLI e LEVERINI	24
ARTICOLI PER PIETRA	26
SECCHI, CAZZUOLE, SPATOLE e VARIE	27
BADILI, PALE, RASCHIETTI e RASCHIAFANGO	39
ACCETTE, PICOZZINI, RONCOLE e MACETE	52
ASCE, MAZZESCURI e CUNEI	55
RASTRELLI, SARCHIATORI e AERATORI	61
SCOPE FOGLIE	69
RACCOLTA FRUTTA e TRATTAMENTO	78
NOVITÀ	84
FORCHE e VANGHE	90
ZAPPE, ZAPPINI, ATTREZZINI e FORBICI	94
MANICI FIBRA	101
MANICI MIX e LEGNO	115
ASTE TELESCOPICHE	123
ESPOSITORI	124
<b>GUANTI</b>	<b>126</b>
SOLLEVAMENTO e ANCORAGGIO	140

## GUANTI SKY-MIX

SKY-MIX GLOVES  
GANTS SKY-MIX

COD. ART.	Tipo	Colore	Taglia	L mm	Confezione	BOX	COD. EAN - 13
GLA-06	Sky-Mix	Blu	6	210	12 pz.	120 pz.	80 5773372 112 4
GLA-07	Sky-Mix	Blu	7	220	12 pz.	120 pz.	80 5773372 113 1
GLA-08	Sky-Mix	Blu	8	230	12 pz.	120 pz.	80 5773372 114 8
GLA-09	Sky-Mix	Blu	9	240	12 pz.	120 pz.	80 5773372 115 5
GLA-10	Sky-Mix	Blu	10	250	12 pz.	120 pz.	80 5773372 116 2
GLA-11	Sky-Mix	Blu	11	260	12 pz.	120 pz.	80 5773372 117 9

Cat 2. Testati secondo la Norma EN 388	Livello
Resistenza all'abrasione	2
Resistenza al taglio di lama	1
Resistenza allo strappo	3
Resistenza alla puntura	1

Confezionamento
<b>Appendino</b> Hanger Cintre



### OTTIMO SOFT-TOUCH

Excellent soft touch  
Excellente soft touch

### OTTIMA FLESSIBILITÀ E SENSIBILITÀ

Excellent flexibility and sensibility  
Excellente flexibilité et sensibilité

### OTTIMO GRIP

Excellent grip  
Grip exceptionnel



### IMPERMEABILE

Waterproof  
Impermeable

### DITA E DORSO AREATI

Areated back and fingers  
Doigts et dos ventilés

- 4 MARTELLERIA
- 20 MAZZE e PICCONI
- 24 SCALPELLI e LEVERINI
- 26 ARTICOLI PER PIETRA
- 27 SECCHI, CAZZUOLE, SPATOLE e VARIE
- 39 BADILI, PALE, RASCHIETTI e RASCHIAFANGO
- 52 ACCETTE, PICOZZINI, RONCOLE e MACETE
- 55 ASCE, MAZZESCURI e CUNEI
- 61 RASTRELLI, SARCHIATORI e AERATORI
- 69 SCOPE FOGLIE
- 78 RACCOLTA FRUTTA e TRATTAMENTO
- 84 NOVITÀ
- 90 FORCHE e VANGHE
- 94 ZAPPE, ZAPPINI, ATTREZZINI e FORBICI
- 101 MANICI FIBRA
- 115 MANICI MIX e LEGNO
- 123 ASTE TELESCOPICHE
- 124 ESPOSITORI
- 126 **GUANTI**
- 140 SOLLEVAMENTO e ANCORAGGIO

## GUANTI POLIMIX

POLIMIX GLOVES  
GANTS POLIMIX

COD. ART.	Tipo	Colore	Taglia	L mm	Confezione	BOX	COD. EAN - 13
GPU07	Polimix	Nero	7	220	12 pz.	120 pz.	80 3264633 074 8
GPU08	Polimix	Nero	8	230	12 pz.	120 pz.	80 3264633 459 3
GPU09	Polimix	Nero	9	240	12 pz.	120 pz.	80 3264633 488 3
GPU10	Polimix	Nero	10	250	12 pz.	120 pz.	80 3264633 489 0
GPU11	Polimix	Nero	11	260	12 pz.	120 pz.	80 3264633 180 6

Cat 2. Testati secondo la Norma EN 388	Livello
Resistenza all'abrasione	4
Resistenza al taglio di lama	1
Resistenza allo strappo	3
Resistenza alla puntura	1

Confezionamento
Appendino Hanger Cintre



### BUONA SENSIBILITÀ

Good sensibility  
Bonne sensibilité

### DORSO E DITA AREATE

Areated back and fingers  
Doigts et dos ventilés

### SOTTILE E RESISTENTE

Thin and resistant  
Mince et résistant

### OTTIMA RESITENZA ALL'ABRASIONE

Excellent resistance to abrasion  
Excellente résistance à l'abrasion

### FILO IN NYLON

Nylon thread  
Fil de nylon

### FRESCHI E LEGGERISSIMI

Fresh and very light  
Frais et beaucoup léger



MARTELLERIA 4

MAZZE e PICCONI 20

SCALPELLI e LEVERINI 24

ARTICOLI PER PIETRA 26

SECCHI, CAZZUOLE, SPATOLE e VARIE 27

BADILI, PALE, RASCHIETTI e RASCHIAFANGO 39

ACCETTE, PICOZZINI, RONCOLE e MACETE 52

ASCE, MAZZESCURI e CUNEI 55

RASTRELLI, SARCHIATORI e AERATORI 61

SCOPE FOGLIE 69

RACCOLTA FRUTTA e TRATTAMENTO 78

NOVITÀ 84

FORCHE e VANGHE 90

ZAPPE, ZAPPINI, ATTREZZINI e FORBICI 94

MANICI FIBRA 101

MANICI MIX e LEGNO 115

ASTE TELESCOPICHE 123

ESPOSITORI 124

**GUANTI 126**

SOLLEVAMENTO e ANCORAGGIO 140

## GUANTI GRE-MIX

GRE-MIX GLOVES  
GANTS GRE-MIX

COD. ART.	Tipo	Colore	Taglia	L mm	Confezione	BOX	COD. EAN - 13
GRE-07	Gre-Mix	Grigio	7	220	12 pz.	120 pz.	80 5773372 107 0
GRE-08	Gre-Mix	Grigio	8	230	12 pz.	120 pz.	80 5773372 108 7
GRE-09	Gre-Mix	Grigio	9	240	12 pz.	120 pz.	80 5773372 109 4
GRE-10	Gre-Mix	Grigio	10	250	12 pz.	120 pz.	80 5773372 110 0
GRE-11	Gre-Mix	Grigio	11	260	12 pz.	120 pz.	80 5773372 111 7

Cat 2. Testati secondo la Norma EN 388	Livello
Resistenza all'abrasione	4
Resistenza al taglio di lama	1
Resistenza allo strappo	3
Resistenza alla puntura	1

Confezionamento
<b>Appendino</b> Hanger Cintre



**FRESCHI E LEGGERI**

Fresh and light  
Frais et léger



**BUONA RESITENZA ALL'ABRASIONE**

Good resistance to abrasion  
Bonne résistance à l'abrasion

**FILO IN POLIESTERE**

Polyester thread  
Fil de polyester

**DORSO E DITA AREATE**

Areated back and fingers  
Doigts et dos ventilés

4 MARTELLERIA

20 MAZZE e PICCONI

24 SCALPELLI e LEVERINI

26 ARTICOLI PER PIETRA

27 SECCHI, CAZZUOLE, SPATOLE e VARIE

39 BADILI, PALE, RASCHIETTI e RASCHIAFANGO

52 ACCETTE, PICOZZINI, RONCOLE e MACETE

55 ASCE, MAZZESCURI e CUNEI

61 RASTRELLI, SARCHIATORI e AERATORI

69 SCOPE FOGLIE

78 RACCOLTA FRUTTA e TRATTAMENTO

84 NOVITÀ

90 FORCHE e VANGHE

94 ZAPPE, ZAPPINI, ATTREZZINI e FORBICI

101 MANICI FIBRA

115 MANICI MIX e LEGNO

123 ASTE TELESCOPICHE

124 ESPOSITORI

126 **GUANTI**

140 SOLLEVAMENTO e ANCORAGGIO

## GUANTI MIX

MIX GLOVES  
GANTS MIX

COD. ART.	Tipo	Colore	Taglia	L mm	Confezione	BOX	COD. EAN - 13
GGB_E07	Mix	Grigio	7	220	12 pz.	120 pz.	80 3264633 263 6
GGB_E08	Mix	Grigio	8	230	12 pz.	120 pz.	80 3264633 281 0
GGB_E09	Mix	Grigio	9	240	12 pz.	120 pz.	80 3264633 282 7
GGB_E10	Mix	Grigio	10	250	12 pz.	120 pz.	80 3264633 283 4
GGB_E11	Mix	Grigio	11	260	12 pz.	120 pz.	80 3264633 667 2

Cat 2. Testati secondo la Norma EN 388	Livello
Resistenza all'abrasione	3
Resistenza al taglio di lama	1
Resistenza allo strappo	2
Resistenza alla puntura	1

Confezionamento
Appendino
Hanger
Cintre



### BUONA SENSIBILITÀ

Good sensibility  
Bonne sensibilité

### NITRILE DI QUALITÀ

Good quality nitrile  
Nitrile de bonne qualité



### IMPERMEABILI

Waterproof  
Impermeable

### DITA E DORSO AREATI

Areated back and fingers  
Doigts et dos ventilés

MARTELLERIA 4

MAZZE e PICCONI 20

SCALPELLI e LEVERINI 24

ARTICOLI PER PIETRA 26

SECCHI, CAZZUOLE, SPATOLE e VARIE 27

BADILI, PALE, RASCHIETTI e RASCHIAFANGO 39

ACCETTE, PICOZZINI, RONCOLE e MACETE 52

ASCE, MAZZESCURI e CUNEI 55

RASTRELLI, SARCHIATORI e AERATORI 61

SCOPE FOGLIE 69

RACCOLTA FRUTTA e TRATTAMENTO 78

NOVITÀ 84

FORCHE e VANGHE 90

ZAPPE, ZAPPINI, ATTREZZINI e FORBICI 94

MANICI FIBRA 101

MANICI MIX e LEGNO 115

ASTE TELESCOPICHE 123

ESPOSITORI 124

**GUANTI 126**

SOLLEVAMENTO e ANCORAGGIO 140

## GUANTI E-MIX

E-MIX GLOVES  
GANTS E-MIX

COD. ART.	Tipo	Colore	Taglia	L mm	Confezione	BOX	COD. EAN - 13
EM-07	E-Mix	Nero	7	220	12 pz.	120 pz.	80 5773372 285 5
EM-08	E-Mix	Nero	8	230	12 pz.	120 pz.	80 3264633 609 2
EM-09	E-Mix	Nero	9	240	12 pz.	120 pz.	80 3264633 610 8
EM-10	E-Mix	Nero	10	250	12 pz.	120 pz.	80 3264633 611 5
EM-11	E-Mix	Nero	11	260	12 pz.	120 pz.	80 3264633 612 2

Cat 2. Testati secondo la Norma EN 388	Livello
Resistenza all'abrasione	2
Resistenza al taglio di lama	1
Resistenza allo strappo	2
Resistenza alla puntura	1

Confezionamento
<b>Appendino</b> Hanger Cintre



### IMPERMEABILE

Waterproof  
Impermeables

### BUONA SENSIBILITÀ

Good sensibility  
Bonne sensibilité



### BUON GRIP

Good grip  
Bonne Grip

### FILO IN POLIESTERE

Polyester thread  
Fil de polyester

### DITA E DORSO AREATI

Areated back and fingers  
Doigts et dos ventilés

- 4 MARTELLERIA
- 20 MAZZE e PICCONI
- 24 SCALPELLI e LEVERINI
- 26 ARTICOLI PER PIETRA
- 27 SECCHI, CAZZUOLE, SPATOLE e VARIE
- 39 BADILI, PALE, RASCHIETTI e RASCHIAFANGO
- 52 ACCETTE, PICOZZINI, RONCOLE e MACETE
- 55 ASCE, MAZZESCURI e CUNEI
- 61 RASTRELLI, SARCHIATORI e AERATORI
- 69 SCOPE FOGLIE
- 78 RACCOLTA FRUTTA e TRATTAMENTO
- 84 NOVITÀ
- 90 FORCHE e VANGHE
- 94 ZAPPE, ZAPPINI, ATTREZZINI e FORBICI
- 101 MANICI FIBRA
- 115 MANICI MIX e LEGNO
- 123 ASTE TELESCOPICHE
- 124 ESPOSITORI
- 126 **GUANTI**
- 140 SOLLEVAMENTO e ANCORAGGIO



## GUANTI GO-MIX

GO-MIX GLOVES  
GANTS GO-MIX

COD. ART.	Tipo	Colore	Taglia	L mm	Confezione	BOX	COD. EAN - 13
GM-09	Go-Mix	Blu	9	240	12 pz.	120 pz.	80 5773372 105 6
GM-10	Go-Mix	Blu	10	250	12 pz.	120 pz.	80 5773372 106 3

Cat 2. Testati secondo la Norma EN 388	Livello
Resistenza all'abrasione	3
Resistenza al taglio di lama	1
Resistenza allo strappo	2
Resistenza alla puntura	1

Confezionamento
<p><b>Appendino</b></p> <p>Hanger</p> <p>Cintre</p>



### IMPERMEABILE

Waterproof  
Impermeable



### RIVESTIMENTO IN NBR

NBR coating  
Revêtement en NBR

### SUPPORTO TELA/COTONE

Canvas/cotton holder  
Support toile/coton

MARTELLERIA 4

MAZZE e PICCONI 20

SCALPELLI e LEVERINI 24

ARTICOLI PER PIETRA 26

SECCHI, CAZZUOLE, SPATOLE e VARIE 27

BADILI, PALE, RASCHIETTI e RASCHIAFANGO 39

ACCETTE, PICOZZINI, RONCOLE e MACETE 52

ASCE, MAZZESCURI e CUNEI 55

RASTRELLI, SARCHIATORI e AERATORI 61

SCOPE FOGLIE 69

RACCOLTA FRUTTA e TRATTAMENTO 78

NOVITÀ 84

FORCHE e VANGHE 90

ZAPPE, ZAPPINI, ATTREZZINI e FORBICI 94

MANICI FIBRA 101

MANICI MIX e LEGNO 115

ASTE TELESCOPICHE 123

ESPOSITORI 124

**GUANTI 126**

SOLLEVAMENTO e ANCORAGGIO 140

## GUANTI BLACK DOT GLOVE TANK

BLACK DOT GLOVE TANK GLOVES  
GANTS BLACK DOT GLOVE TANK

COD. ART.	Tipo	Colore	Taglia	L mm	Confezione	BOX	COD. EAN - 13
17145 GNP 08	Black Dot Glove Tank	Nero	8	230	12 pz.	144 pz.	80 3264633 214 8
17145 GNP 09	Black Dot Glove Tank	Nero	9	240	12 pz.	144 pz.	80 3264633 215 5
17145 GNP 10	Black Dot Glove Tank	Nero	10	250	12 pz.	144 pz.	80 3264633 216 2
17145 GNP 11	Black Dot Glove Tank	Nero	11	260	12 pz.	144 pz.	80 3264633 217 9

Cat 2. Testati secondo la Norma EN 388	Livello
Resistenza all'abrasione	4
Resistenza al taglio di lama	3
Resistenza allo strappo	4
Resistenza alla puntura	2

Confezionamento
<b>Appendino</b> Hanger Cintre



**ANTI-USURA**  
Anti-wear  
Anti-usure

**BUONA RESISTENZA AL TAGLIO**

Good resistance to cut  
Bonne resistance au coupe

**TRASPIRANTE**

Transpiring  
Transpirants



**ANTI-STRAPPO**  
Anti-tear  
Résistant à la déchirure

4 MARTELLERIA

20 MAZZE e PICCONI

24 SCALPELLI e LEVERINI

26 ARTICOLI PER PIETRA

27 SECCHI, CAZZUOLE, SPATOLE e VARIE

39 BADILI, PALE, RASCHIETTI e RASCHIAFANGO

52 ACCETTE, PICOZZINI, RONCOLE e MACETE

55 ASCE, MAZZESCURI e CUNEI

61 RASTRELLI, SARCHIATORI e AERATORI

69 SCOPE FOGLIE

78 RACCOLTA FRUTTA e TRATTAMENTO

84 NOVITÀ

90 FORCHE e VANGHE

94 ZAPPE, ZAPPINI, ATTREZZINI e FORBICI

101 MANICI FIBRA

115 MANICI MIX e LEGNO

123 ASTE TELESCOPICHE

124 ESPOSITORI

126 **GUANTI**

140 SOLLEVAMENTO e ANCORAGGIO

## GUANTI TERMOFLEX

TERMOFLEX GLOVES  
GANTS TERMOFLEX

COD. ART.	Tipo	Colore	Taglia	L mm	Confezione	BOX	COD. EAN - 13
18145 GN 08	Termoflex	Giallo Nero	8	230	12 pz.	120 pz.	80 3264633 682 5
18145 GN 09	Termoflex	Giallo Nero	9	240	12 pz.	120 pz.	80 3264633 683 2
18145 GN 10	Termoflex	Giallo Nero	10	250	12 pz.	120 pz.	80 3264633 684 9
18145 GN 11	Termoflex	Giallo Nero	11	260	12 pz.	120 pz.	80 3264633 685 6

Cat 2. Testati secondo la Norma EN 388	Livello
Resistenza all'abrasione	3
Resistenza al taglio di lama	2
Resistenza allo strappo	4
Resistenza alla puntura	2
Freddo convettivo	2
Freddo da contatto	2
Penetrazione all'acqua	X

Confezionamento
<p>Appendino</p> <p>Hanger</p> <p>Cintre</p>



**TERMICO**  
Thermic  
Thermique

**BUONA MANEGGEVOLEZZA**

Good handiness  
Bonne maniabilité



**POLSINO ALLUNGATO**  
Extended cuff  
Poignet allongé

**BUONA RESISTENZA**  
Good endurance  
Bonne résistance

MARTELLERIA 4

MAZZE e PICCONI 20

SCALPELLI e LEVERINI 24

ARTICOLI PER PIETRA 26

SECCHI, CAZZUOLE, SPATOLE e VARIE 27

BADILI, PALE, RASCHIETTI e RASCHIAFANGO 39

ACCETTE, PICOZZINI, RONCOLE e MACETE 52

ASCE, MAZZESCURI e CUNEI 55

RASTRELLI, SARCHIATORI e AERATORI 61

SCOPE FOGLIE 69

RACCOLTA FRUTTA e TRATTAMENTO 78

NOVITÀ 84

FORCHE e VANGHE 90

ZAPPE, ZAPPINI, ATTREZZINI e FORBICI 94

MANICI FIBRA 101

MANICI MIX e LEGNO 115

ASTE TELESCOPICHE 123

ESPOSITORI 124

**GUANTI 126**

SOLLEVAMENTO e ANCORAGGIO 140

- 4 MARTELLERIA
- 20 MAZZE e PICCONI
- 24 SCALPELLI e LEVERINI
- 26 ARTICOLI PER PIETRA
- 27 SECCHI, CAZZUOLE, SPATOLE e VARIE
- 39 BADILI, PALE, RASCHIETTI e RASCHIAFANGO
- 52 ACCETTE, PICOZZINI, RONCOLE e MACETE
- 55 ASCE, MAZZESCURI e CUNEI
- 61 RASTRELLI, SARCHIATORI e AERATORI
- 69 SCOPE FOGLIE
- 78 RACCOLTA FRUTTA e TRATTAMENTO
- 84 NOVITÀ
- 90 FORCHE e VANGHE
- 94 ZAPPE, ZAPPINI, ATTREZZINI e FORBICI
- 101 MANICI FIBRA
- 115 MANICI MIX e LEGNO
- 123 ASTE TELESCOPICHE
- 124 ESPOSITORI
- 126 GUANTI
- 140 SOLLEVAMENTO e ANCORAGGIO

### Tendifilo in ottone per barre stendibiancheria da balcone

Brass thread tensioner for balcony washing lines  
Tendeur de fils en laiton pour cordes a ligne de balcon

COD. ART.	L mm chiuso	L mm aperto	BOX	COD. EAN - 13
TFO	43 mm	70 mm	10	80 3264633 584 2
Mercato / Markets / Marchés				



### VELOCE - DURATURO - SUPER SICURO - FACILE UTILIZZO

*Fast - Lasting - Extra safe - Easy use*

*Rapide - Durable - Super sûr - Utilisation facile*

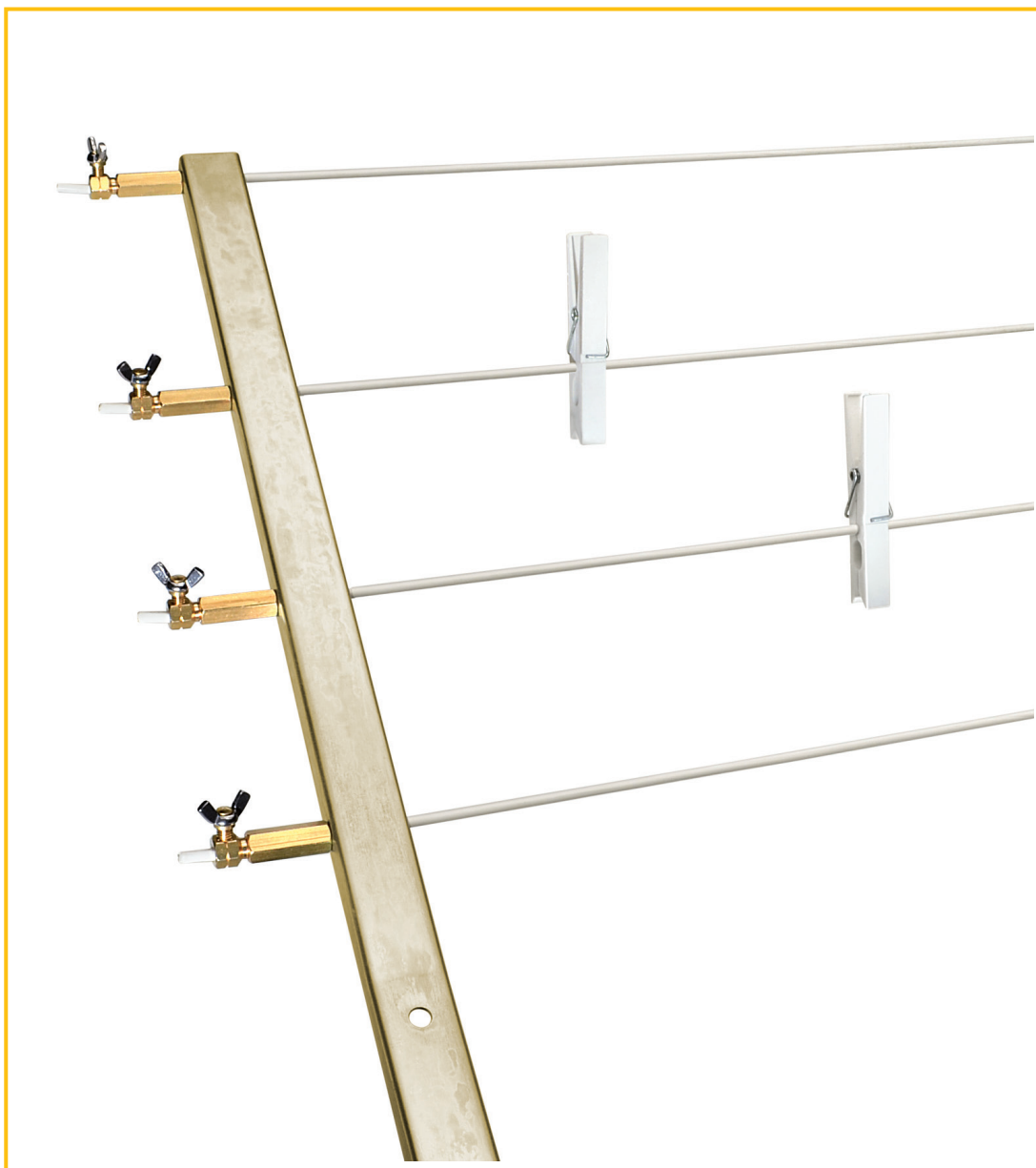

**Brache in poliestere colorate doppio strato soles rivestite**  
**COEFFICIENTE DI SICUREZZA 7:1**

Le portate ed il coefficiente di sicurezza sono considerate a funi nuove.  
Attenersi nell'uso a quanto previsto nelle istruzioni allegate.

COD. ART.	L mm	PORTATA	PORTATA IN DOPPIA	MT.	COLORE	COD. EAN - 13
ESP 1001	50	1000 Kg	2000 Kg	1	●	80 3264633 129 5
ESP 1002	50	1000 Kg	2000 Kg	2	●	80 3264633 131 8
ESP 1003	50	1000 Kg	2000 Kg	3	●	80 3264633 132 5
ESP 1004	50	1000 Kg	2000 Kg	4	●	80 3264633 133 2
ESP 1005	50	1000 Kg	2000 Kg	5	●	80 3264633 134 9
ESP 1006	50	1000 Kg	2000 Kg	6	●	80 3264633 135 6
ESP 2001	60	2000 Kg	4000 Kg	1	●	80 3264633 136 3
ESP 2002	60	2000 Kg	4000 Kg	2	●	80 3264633 137 0
ESP 2003	60	2000 Kg	4000 Kg	3	●	80 3264633 138 7
ESP 2004	60	2000 Kg	4000 Kg	4	●	80 3264633 139 4
ESP 2005	60	2000 Kg	4000 Kg	5	●	80 3264633 141 7
ESP 2006	60	2000 Kg	4000 Kg	6	●	80 3264633 142 4
ESP 3002	90	3000 Kg	6000 Kg	2	●	80 3264633 143 1
ESP 3003	90	3000 Kg	6000 Kg	3	●	80 3264633 144 8
ESP 3004	90	3000 Kg	6000 Kg	4	●	80 3264633 145 5
ESP 3005	90	3000 Kg	6000 Kg	5	●	80 3264633 147 9
ESP 3006	90	3000 Kg	6000 Kg	6	●	80 3264633 148 6

Mercato / Markets / Marchés EU

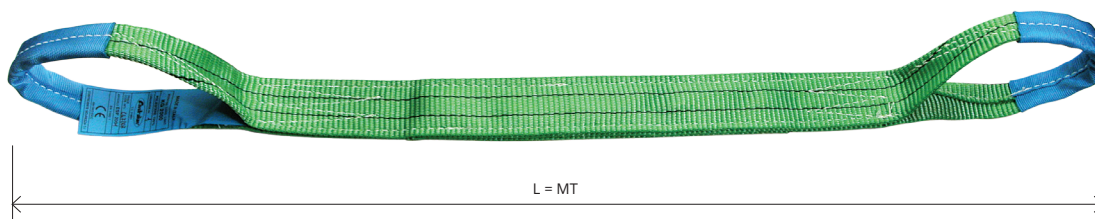
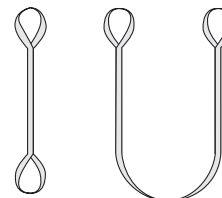

MARTELLERIA	4
MAZZE e PICCONI	20
SCALPELLI e LEVERINI	24
ARTICOLI PER PIETRA	26
SECCHI, CAZZUOLE, SPATOLE e VARIE	27
BADILI, PALE, RASCHIETTI e RASCHIAFANGO	39
ACCETTE, PICOZZINI, RONCOLE e MACETE	52
ASCE, MAZZESCURI e CUNEI	55
RASTRELLI, SARCHIATORI e AERATORI	61
SCOPE FOGLIE	69
RACCOLTA FRUTTA e TRATTAMENTO	78
NOVITÀ	84
FORCHE e VANGHE	90
ZAPPE, ZAPPINI, ATTREZZINI e FORBICI	94
MANICI FIBRA	101
MANICI MIX e LEGNO	115
ASTE TELESCOPICHE	123
ESPOSITORI	124
GUANTI	126
<b>SOLLEVAMENTO e ANCORAGGIO</b>	<b>140</b>

- 4 MARTELLERIA
- 20 MAZZE e PICCONI
- 24 SCALPELLI e LEVERINI
- 26 ARTICOLI PER PIETRA
- 27 SECCHI, CAZZUOLE, SPATOLE e VARIE
- 39 BADILI, PALE, RASCHIETTI e RASCHIAFANGO
- 52 ACCETTE, PICOZZINI, RONCOLE e MACETE
- 55 ASCE, MAZZESCURI e CUNEI
- 61 RASTRELLI, SARCHIATORI e AERATORI
- 69 SCOPE FOGLIE
- 78 RACCOLTA FRUTTA e TRATTAMENTO
- 84 NOVITÀ
- 90 FORCHE e VANGHE
- 94 ZAPPE, ZAPPINI, ATTREZZINI e FORBICI
- 101 MANICI FIBRA
- 115 MANICI MIX e LEGNO
- 123 ASTE TELESCOPICHE
- 124 ESPOSITORI
- 126 GUANTI
- 140 SOLLEVAMENTO e ANCORAGGIO

### Dispositivo di ancoraggio serie 50 mm con tensionatore GANCI A SPONDA

Anchoring device series 50 mm. with tensioner side hooks  
Dispositif d'anchrage série 50 mm avec tensionneur côté crochet

**Carico di rottura 50 daN**  
**Carico di utilizzo 25 daN**

Breaking load / Charge de rupture 50 daN  
Normal using load / utilisation normale 25 daN

COD. ART.	TYPE	MT.	COD. EAN - 13
RS 503		8,5	80 3264633 219 3
RS 503/L		12,5	80 3264633 220 9
Mercato / Markets / Marchés			



### Dispositivo di ancoraggio serie 50 mm con tensionatore GANCI AD UNCINO

Anchoring device series 50 mm. with tensioner joined hooks  
Dispositif d'anchrage série 50 mm à tensionneur avec crochet à proche

**Carico di rottura 50 daN**  
**Carico di utilizzo 25 daN**

Breaking load / Charge de rupture 50 daN  
Normal using load / utilisation normale 25 daN

COD. ART.	TYPE	MT.	COD. EAN - 13
RS 502		8,5	80 3264633 527 9
RS 502/L		12,5	80 3264633 528 6
Mercato / Markets / Marchés			



### Fascia ricambio per ancoraggio serie 50 mm con GANCI A SPONDA

Spare Belt for anchoring device series 50 mm. with tensioner side hooks  
Bande de rechange pour dispositif d'anchrage série 50 mm avec tensionneur côté crochet

**Carico di rottura 50 daN**  
**Carico di utilizzo 25 daN**

Breaking load / Charge de rupture 50 daN  
Normal using load / utilisation normale 25 daN

COD. ART.	TYPE	MT.	COD. EAN - 13
S 503		8	80 3264633 221 6
Mercato / Markets / Marchés			



**TUTTE LE PORTATE ED IL COEFFICIENTE DI SICUREZZA SONO CONSIDERATE A FUNI NUOVE**

THE LOADINGS SHOWN ARE VALID WITH NEW BELTS



LES VALEURS DE CHARGE INDIQUÉES SONT VALIDES AVEC BANDES NOUVEAUX

**Dispositivo di ancoraggio serie 35 mm  
con tensionatore GANCI A SPONDA**

Anchoring device series 35 mm. with tensioner side hooks  
Dispositif d'anchrage série 35 mm avec tensionneur côté crochet

**Carico di rottura 20 daN**  
**Carico di utilizzo 10 daN**

Breaking load / Charge de rupture 20 daN  
Normal using load / utilisation normale 10 daN

COD. ART.	TYPE	MT.	COD. EAN - 13
RHL 352		5,5+0,5	80 3264633 222 3
Mercato / Markets / Marchés			

**STRAPPO 2000 KG**



MARTELLERIA 4

MAZZE e  
PICCONI 20

SCALPELLI e  
LEVERINI 24

ARTICOLI PER  
PIETRA 26

SECCHI, CAZZUOLE,  
SPATOLE e VARIE 27

BADILI, PALE,  
RASCHIETTI  
e RASCHIAFANGO 39

ACCETTE, PICOZZINI,  
RONCOLE e MACETE 52

ASCE, MAZZESCURI  
e CUNEI 55

RASTRELLI,  
SARCHIATORI  
e AERATORI 61

SCOPE FOGLIE 69

RACCOLTA FRUTTA  
e TRATTAMENTO 78

NOVITÀ 84

FORCHE  
e VANGHE 90

ZAPPE, ZAPPINI,  
ATTREZZINI  
e FORBICI 94

MANICI FIBRA 101

MANICI MIX  
e LEGNO 115

ASTE  
TELESCOPICHE 123

ESPOSITORI 124

GUANTI 126



**SOLLEVAMENTO  
e ANCORAGGIO 140**

**Dispositivo di ancoraggio serie 35 mm  
con tensionatore GANCI AD UNCINO**

Anchoring device series 35 mm. with tensioner joined hooks  
Dispositif d'anchrage série 35 mm à tensionneur avec crochet à proche

**Carico di rottura 20 daN**  
**Carico di utilizzo 10 daN**

Breaking load / Charge de rupture 20 daN  
Normal using load / utilisation normale 10 daN

COD. ART.	TYPE	MT.	COD. EAN - 13
RHL 353		5,5+0,35	80 3264633 530 9
Mercato / Markets / Marchés			

**STRAPPO 2000 KG**





**Dispositivo di ancoraggio serie 25 mm  
con tensionatore GANCIO A "S"**

Anchoring device series 25 mm. with tensioner "S" hooks  
Dispositif d'anchrage série 25 mm à tensionneur avec crochet à "S"

**Carico di rottura 6 daN**  
**Carico di utilizzo 3 daN**

Breaking load / Charge de rupture 6 daN  
Normal using load / utilisation normale 3 daN

COD. ART.	TYPE	MT.	COD. EAN - 13
HL 252		4,5+0,35	80 3264633 532 3
Mercato / Markets / Marchés			

**STRAPPO 600 KG**



**TUTTE LE PORTATE ED IL COEFFICIENTE DI SICUREZZA SONO CONSIDERATE A FUNI NUOVE**

THE LOADINGS SHOWN ARE VALID WITH NEW BELTS

LES VALEURS DE CHARGE INDIQUÉES SONT VALIDES AVEC BANDES NOUVEAUX

4 MARTELLERIA

**Dispositivo di ancoraggio  
a fibbia semplice serie 35 mm**

 Anchoring device series 35 mm.  
Dispositif d'anchrage série 35 mm

**Carico di rottura 8 daN**  
**Carico di utilizzo 4 daN**

 Breaking load / Charge de rupture 8 daN  
Normal using load / utilisation normale 4 daN

COD. ART.	TYPE	MT.	COD. EAN - 13
MB 351		5	80 3264633 504 0

 Mercato / Markets / Marchés 
**STRAPPO 800 KG**

 20 MAZZE e  
PICCONI

 24 SCALPELLI e  
LEVERINI

 26 ARTICOLI PER  
PIETRA

 27 SECCHI, CAZZUOLE,  
SPATOLE e VARIE

 39 BADILI, PALE,  
RASCHIETTI  
e RASCHIAFANGO

 52 ACCETTE, PICOZZINI,  
RONCOLE e MACETE

 55 ASCE, MAZZESCURI  
e CUNEI

 61 RASTRELLI,  
SARCHIATORI  
e AERATORI

69 SCOPE FOGLIE

 78 RACCOLTA FRUTTA  
e TRATTAMENTO

84 NOVITÀ

 90 FORCHE  
e VANGHE

 94 ZAPPE, ZAPPINI,  
ATTREZZINI  
e FORBICI

101 MANICI FIBRA

 115 MANICI MIX  
e LEGNO

 123 ASTE  
TELESCOPICHE

124 ESPOSITORI

126 GUANTI

 140 SOLLEVAMENTO  
e ANCORAGGIO

**Dispositivo di ancoraggio  
a fibbia semplice serie 25 mm**

 Anchoring device series 25 mm  
Dispositif d'anchrage série 25 mm

**Carico di rottura 3 daN**  
**Carico di utilizzo 1,5 daN**

 Breaking load / Charge de rupture 3 daN  
Normal using load / utilisation normale 1,5 daN

COD. ART.	TYPE	MT.	COD. EAN - 13
MB 251		5	80 3264633 535 4

 Mercato / Markets / Marchés 
**STRAPPO 250 KG**

**Dispositivo di ancoraggio  
a fibbia semplice serie 25 mm**

 Anchoring device series 25 mm  
Dispositif d'anchrage série 25 mm

**Carico di rottura 3 daN**  
**Carico di utilizzo 1,5 daN**

 Breaking load / Charge de rupture 3 daN  
Normal using load / utilisation normale 1,5 daN

COD. ART.	TYPE	MT.	COD. EAN - 13
MB 252		2,5	80 3264633 534 7

 Mercato / Markets / Marchés 
**STRAPPO 250 KG**

**TUTTE LE PORTATE ED IL COEFFICIENTE DI SICUREZZA SONO CONSIDERATE A FUNI NUOVE**

THE LOADINGS SHOWN ARE VALID WITH NEW BELTS

LES VALEURS DE CHARGE INDIQUÉES SONT VALIDES AVEC BANDES NOUVEAUX



## CONDIZIONI GENERALI DI VENDITA

### 1. LA SPEDIZIONE

Viene eseguita secondo richiesta del cliente; in mancanza di precisazioni verrà fatta col mezzo da noi ritenuto più idoneo. La merce viene resa franco partenza. La merce viaggia a rischio e pericolo del Committente anche se spedita in porto franco.

### 2. PAGAMENTI

Dovranno essere effettuati, nei termini concordati, esclusivamente alla nostra sede o a persone da noi autorizzate e non sono ammesse trattenute arbitrarie ed arrotondamenti. Per i pagamenti ritardati saranno conteggiati interessi commerciali. Trascorsi 30 gg. dal termine di pagamento s'intende revocato ogni sconto pagamento e pertanto le fatture dovranno essere pagate per intero. In caso di mancato pagamento nei termini concordati all'atto del conferimento dell'ordine, intendiamo autorizzata l'emissione della tratta a carico del committente.

## TERMS OF SALE

### 1. DELIVERY

It is carried out in conformity with the customer's request. If there is no specification, the goods will be delivered with the most suitable means of transport. Delivery is ex works and the goods are sent at buyer's risk even if dispatched on free of charge.

### 2. PAYMENTS

Payments should be done within the fixed term, only to our office or to authorized people. No arbitrary deductions and rounding off are admitted. We will charge commercial interests on delayed payments. We will not grant any discount if the payment is 30 days overdue and therefore invoices must be paid for the whole amount. In default of the payment within the term fixed in the order's confirmation, we will draw a draft at the buyer's expense.

### 3. ORDERS

Orders should show specified conditions, delivery place and the requested items in accordance with pictures and descriptions of our catalogue. We are not responsible for misunderstandings when the orders have not the necessary explanations.

### 4. CHANGES

We reserve the right to modify the items of the current catalogue whenever we consider it necessary and without notice, as our aim is to improve continuously our products.

### 3. GLI ORDINI

Devono indicare esattamente il modo ed il luogo di destinazione, l'articolo richiesto secondo le figure e le descrizioni del catalogo. Non rispondiamo per errate interpretazioni degli ordini da parte nostra, quando gli stessi non portino tutti i chiarimenti necessari.

### 4. MODIFICHE

Ci riserviamo il diritto di modificare gli articoli del presente catalogo ogni qualvolta lo riterremo necessario, e senza alcun preavviso, avendo per obiettivo il continuo miglioramento dei nostri prodotti.

## CONDITIONS DE VENTE

### 1. L'EXPÉDITION

Peut se faire suivant la demande du client; à défaut des éclaircissements à ce sujet nous vous expédierons la marchandise par le moyen que nous considérerons le plus indiqué. La marchandise est rendue franco départ. Les marchandises voyagent aux risques et périls du commettant même si expédiées en port franc.

### 2. LES PAIEMENTS

Les paiements devront être effectués dans les délais prescrits exclusivement à notre siège ou à personnes autorisées par nous; retenue arbitraires et arrondissements ne sont pas admis. Pour les paiements retardés des intérêts commerciaux seront comptés. 30 jours après le délai de paiements nous ne pourrons plus vous accorder la remise et pour ça les factures devront être payées pour le montant entier. A défaut de paiement dans le délai prescrit au moment de la commande, nous pourrons autoriser l'émission d'une traite à la charge du client.

### 3. LE COMMANDES

Devront indiquer la façon et le lieu de destination, les articles demandés conformément aux figures et aux descriptions du catalogue. Nous ne répondrons pas pour nos fausses interprétations des commandes quand les mêmes ne donnent pas tous les éclaircissements nécessaires.

### 4. MODIFICATIONS

Nous nous réservons le droit de modifier les articles du présent catalogue toutes les fois que nous jugerons nécessaire sans avis préalable, ayant l'objectif d'améliorer continuellement nos produits.

MARTELLERIA	4
MAZZE e PICCONI	17
SCALPELLI e LEVERINI	24
ARTICOLI PER PIETRA	26
SECCHI, CAZZUOLE, SPATOLE e VARIE	30
BADILI, PALE, RASCHIETTI e RASCHIAFANGO	39
ACCETTE, PICOZZINI, RONCOLE e MACETE	51
ASCE, MAZZESCURI e CUNEI	54
RASTRELLI, SARCHIATORI e AERATORI	60
SCOPE FOGLIE	68
RACCOLTA FRUTTA e TRATTAMENTO	78
NOVITÀ	83
FORCHE e VANGHE	88
ZAPPE, ZAPPINI, ATTREZZINI e FORBICI	92
MANICI FIBRA	98
MANICI MIX e LEGNO	112
ASTE TELESCOPICHE	120
ESPOSITORI	121
GUANTI	123
SOLLEVAMENTO e ANCORAGGIO	138

## NOTE

4	MARTELLERIA	
17	MAZZE e PICCONI	
24	SCALPELLI e LEVERINI	
26	ARTICOLI PER PIETRA	
30	SECCHI, CAZZUOLE, SPATOLE e VARIE	
39	BADILI, PALE, RASCHIETTI e RASCHIAFANGO	
51	ACCETTE, PICOZZINI, RONCOLE e MACETE	
54	ASCE, MAZZESCURI e CUNEI	
60	RASTRELLI, SARCHIATORI e AERATORI	
68	SCOPE FOGLIE	
78	RACCOLTA FRUTTA e TRATTAMENTO	
83	NOVITÀ	
88	FORCHE e VANGHE	
92	ZAPPE, ZAPPINI, ATTREZZINI e FORBICI	
98	MANICI FIBRA	
112	MANICI MIX e LEGNO	
120	ASTE TELESCOPICHE	
121	ESPOSITORI	
123	GUANTI	
138	SOLLEVAMENTO e ANCORAGGIO	



## NOTE

4	MARTELLERIA	
17	MAZZE e PICCONI	
24	SCALPELLI e LEVERINI	
26	ARTICOLI PER PIETRA	
30	SECCHI, CAZZUOLE, SPATOLE e VARIE	
39	BADILI, PALE, RASCHIETTI e RASCHIAFANGO	
51	ACCETTE, PICOZZINI, RONCOLE e MACETE	
54	ASCE, MAZZESCURI e CUNEI	
60	RASTRELLI, SARCHIATORI e AERATORI	
68	SCOPE FOGLIE	
78	RACCOLTA FRUTTA e TRATTAMENTO	
83	NOVITÀ	
88	FORCHE e VANGHE	
92	ZAPPE, ZAPPINI, ATTREZZINI e FORBICI	
98	MANICI FIBRA	
112	MANICI MIX e LEGNO	
120	ASTE TELESCOPICHE	
121	ESPOSITORI	
123	GUANTI	
138	SOLLEVAMENTO e ANCORAGGIO	